

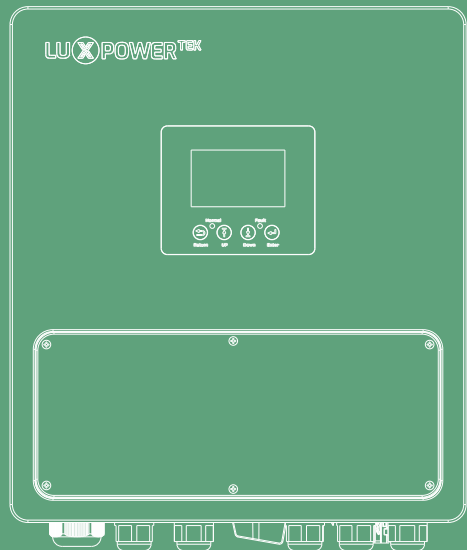

Energy Storage Inverter User Manual

SNA PRO-EU 3-6.5K



Copyright© 2025 Lux Power Technology Co., Ltd. All Rights Reserved. This manual, protected by the copyright and intellectual property rights of Lux Power Technology. No part of this document may not be modified, copied, or reproduced without prior written permission.

All brands and trademarks mentioned belong to their respective owners.

Please read carefully carefully to understand product reliability and warranty eligibility. For detailed warranty information, refer to the Lux Power Technology Limited Warranty. This manual is intended for professional service providers. Nothing in this document constitutes an express or implied warranty.

Descriptions may include forward-looking statements. Actual conditions may differ. This document is provided for reference only and is subject to change without notice by Lux Power Technology Co., Ltd.



Website



YouTube



Facebook

 www.luxpowertek.com



SNA PRO-EU 3-6.5K

Scan to download

Table Of Contents

Information on this Manual	1
Validity	1
Scope	1
Target Group	1
Safety Instructions	1
1. Product Overview	2
1.1 Features of the Inverter	2
1.2 Interface of the Inverter	3
1.3 Packing List	4
1.4 Product Dimensions	5
2. Installation	6
2.1 Preparation	6
2.2 Handling Requirements	6
2.3 Installation Environment Requirements	6
2.4 Installation Tools	7
2.5 Inverter Installation	8
2.6 Battery Connection	10
2.7 Ground Cable Connection	14
2.8 AC Input/Output Connection	15
2.9 CT Connection	16
2.10 PV Connection	18
2.11 GEN Port Function	19
2.11.1 Generator Connection	19
2.11.2 Smart Load Connection	23
2.11.3 AC Coupling Settings	24
2.12 Parallel Function	27
2.13 Power ON/OFF	31
3. Working Modes	31
3.1 Offgrid inverter modes introduction	31

- 3.2 Working Modes related setting description 33
- 3.3 Hybrid Mode Function Overview 34
- 3.4 Monitoring Operation Modes 34
- 4. LCD Display and settings 35**
- 4.1 LED Display 35
- 4.2 LCD Display 36
- 4.3 Inverter Status Display 37
- 4.4 LCD Settings 38
- 5. About LCD Settings check the operation 50**
- 6. SNA Series Inverter Monitoring System 51**
- 7. Specifications 55**
- 8. Maintenance 59**
- 8.1 Power OFF the Inverter 59
- 8.2 Removing the Inverter 59
- 8.3 Disposing of the Inverter 60
- 8.4 Trouble Shooting & Error List 61

Revision History

Version	Date	Description
UM-SNA06001E01	2025.11.26	First official release.

Information on this Manual

Validity

This manual applies to the following models: SNA PRO-EU 3K/SNA PRO-EU 4K/SNA PRO-EU 5K/SNA PRO-EU 6K/SNA PRO-EU 6.5K.

Scope

This manual provides installation, operation, and troubleshooting guidelines for the product. Please read carefully before performing any installation or operation.

Target Group

This manual is intended for both professionals and end users. Professionals and end users should possess the following knowledge and skills:

- Understanding of the operating principles of this device.
- Training in installation and electrical safety.
- Experience in installing and commissioning electrical equipment and systems.
- Familiarity with applicable local standards and regulations.

Safety Instructions

WARNING: This section contains important safety and operating instructions. Please read carefully and keep for future reference.

- All operations and wiring must be carried out by qualified professionals.
- Before using this equipment, carefully read all instructions and warning labels. Any damage caused by improper operation is not covered under LuxpowerTek's warranty.
- All electrical installations must comply with local electrical safety standards.
- Do not disassemble this equipment. For service, contact a qualified service center. Incorrect reassembly may result in electric shock or fire. Opening the inverter housing or replacing any components without Luxpower's authorization will void the warranty.
- To reduce the risk of electric shock, disconnect all wiring before performing any maintenance or cleaning. Simply switching off the device does not eliminate the risk.
- **CAUTION:** To avoid personal injury, charge only deep-cycle lead-acid or lithium batteries. Other types of batteries may explode, causing injury or equipment damage.
- Exercise extreme caution when working near batteries or using metal tools. Dropped tools may cause sparks or short circuits, leading to explosion.
- Do not attempt to charge frozen batteries.
- To ensure optimal performance, always use cables and circuit breakers that meet the recommended specifications.
- When connecting or disconnecting AC or DC terminals, strictly follow the installation instructions. Refer to the "Installation" section of this manual for detailed steps.
- **GROUNDING INSTRUCTIONS:** This equipment must be connected to a permanent grounding system. Installation must comply with all applicable local regulations and requirements.
- Never short-circuit the AC and DC terminals. Do not connect the inverter to the utility grid if the DC input side is short-circuited.

1. Product Overview

1.1 Features of the Inverter

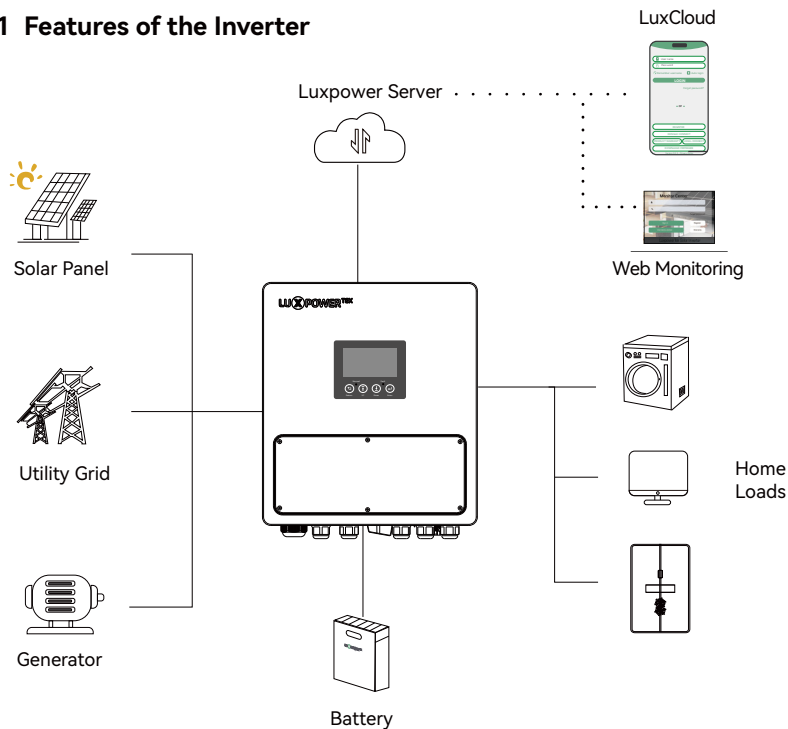

- **Multi-functional High-frequency Pure Sine Wave Off-grid Inverter:** Stable and reliable operation to meet diversified power needs.
- **IP65 Weatherproof Design:** Durable outdoor-ready enclosure ensures reliable performance in harsh environments, including dust, rain, and high humidity.
- **Versatile Applications:** Suitable for off-grid systems, backup power supply, and self-consumption scenarios.
- **Dual MPPT Design:** Wide voltage range of 80–400V to maximize PV generation efficiency.
- **Power Factor 0.6~1.0:** Ensures high-efficiency output.
- **Flexible Battery Configuration:** Supports operation with or without batteries.
- **Dedicated Generator Port:** Enables remote start/stop control of generators.
- **Hybrid Power Supply:** PV and grid power can simultaneously supply the loads.
- **Scalable Parallel Operation:** Supports up to 16 inverters in parallel for flexible capacity expansion.
- **Smart Battery Management:** Compatible with mainstream lithium battery BMS via CAN/RS485 communication.
- **Remote Monitoring & Upgrade:** Supports remote monitoring and firmware upgrade via the dedicated WiFi communication dongle, with access through the free mobile APP (iOS/Android).

1.2 Interface of the Inverter

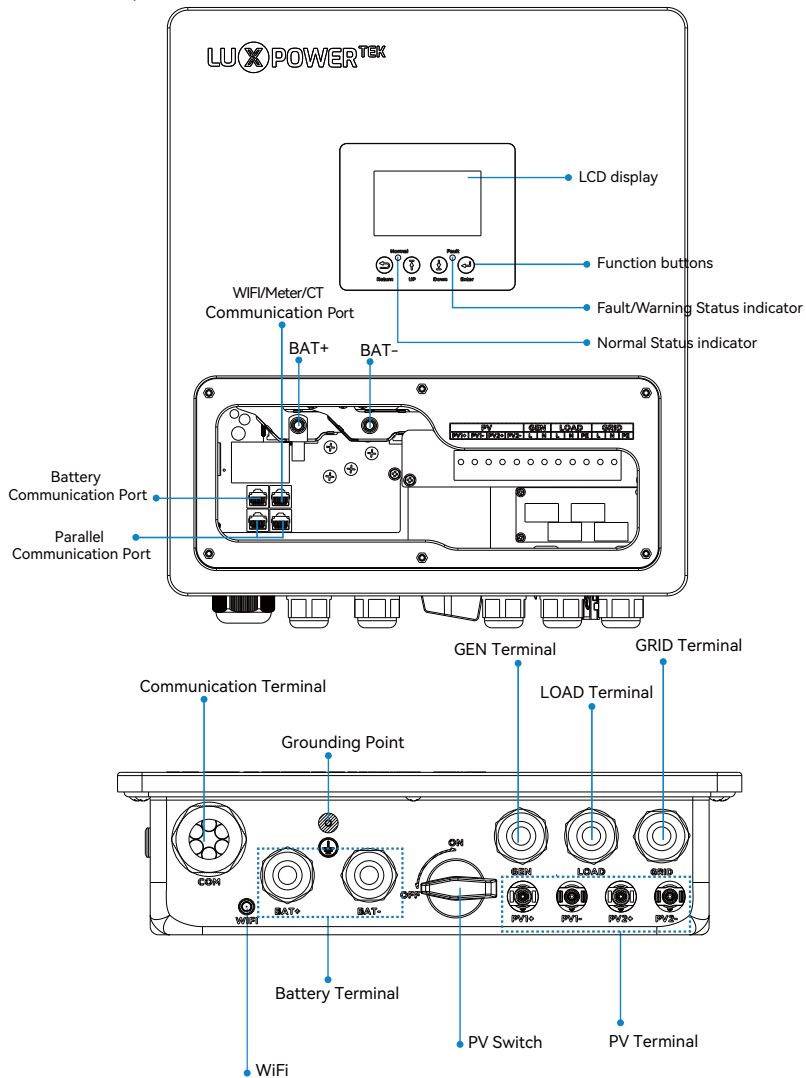

1.3 Packing List

Before installation, please carefully check the package contents. Ensure that all items are complete and in good condition. If any parts are missing or damaged, please contact your distributor immediately.

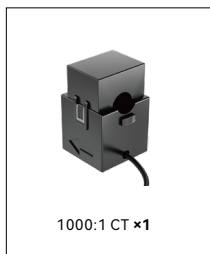
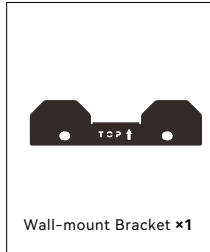
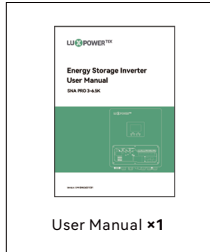
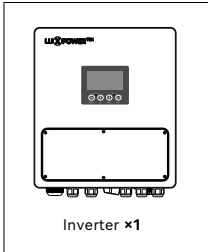

Storage requirements

The inverter must be stored appropriately if not installed immediately, refer to below figure.

⚠ CAUTION

- Must be stored in the original packaging.
- Storage temperature: -25°C to 60°C; humidity: 0-85%.
- Packages must be stored upright, stacked no more than 6 layers, and height less than 2 m.
- Avoid direct sunlight, rain exposure, and corro issive environments.

1.4 Product Dimensions

The overall dimensions of the inverter are shown in the figure below (unit: mm):

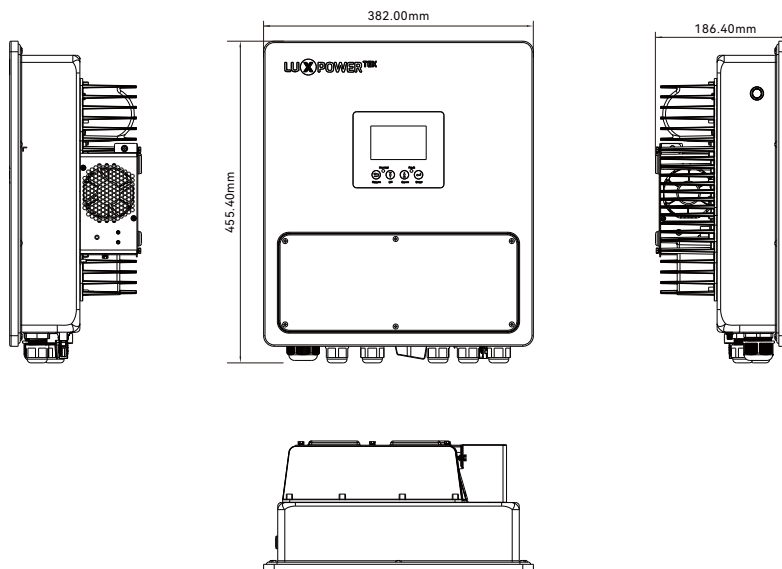

2. Installation

2.1 Preparation

Before installation, please ensure all breakers and cables are prepared in advance. For detailed requirements on cable specifications and circuit breaker parameters, please refer to the subsequent sections (Battery / AC / PV wiring).

System connection diagram:

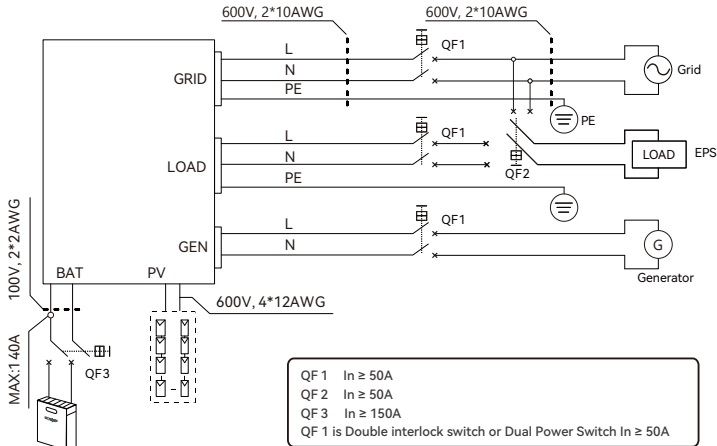

2.2 Handling Requirements

- Handle with care during transportation to avoid impact or dropping.
- It is recommended that two people cooperate or use appropriate handling equipment.
- Do not place heavy objects on top of the inverter.
- Keep the inverter upright during transport and storage.

2.3 Installation Environment Requirements

⚠ During installation and operation, avoid direct sunlight, rain exposure, and snow accumulation on the inverter.

⚠ Do not install the inverter in the following environments:

- Under direct sunlight.
- Areas where flammable or explosive materials are stored.
- Potentially explosive atmospheres.
- Locations directly exposed to cold air outlets.
- Near television antennas or antenna cables.
- At altitudes above 4000 m.
- Areas subject to rainfall or humidity greater than 95%.

2.4 Installation Tools

Recommended tools for installation:

				
Protective goggles	Anti-dust mask	Earplugs	Work shoes	Work gloves
				
Percussion drill	Utility knife	Marker	Slotted screwdriver	Cross screwdriver
				
Pliers	Socket wrenches set	Rubber hammer	Wire cutter	Level
				
Anti-static wrist strap	Wire stripper	Heat gun	Hydraulic pliers	External Hex Socket
				
Crimping tool 4-6 mm ²	Solar connector wrench	Multimeter ≥1100 VDC	RJ45 crimping plier	Cleaner

2.5 Inverter Installation

2.5.1 Requirements for Installation Location

- a. The wall for mounting should be strong enough to bear the weight of inverter.
- b. Please maintain the minimum clearances below for adequate heat dissipation.

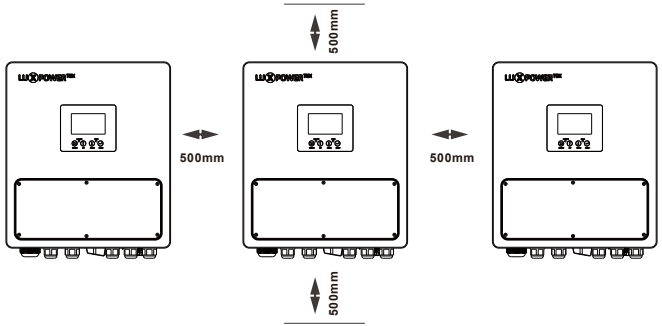

- c. Never install the inverter in a place with direct sunlight, rain or snow. Please refer to below figure and select a well shaded place or install a shed to protect the inverter from direct sunlight, rain and snow etc. Protect the LCD screen from excessive UV exposure.

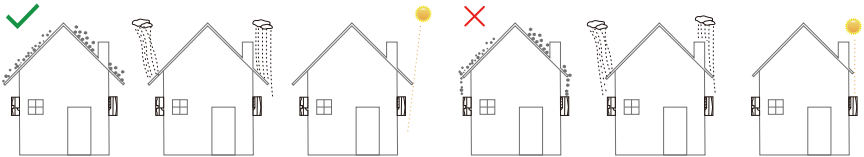

- d. The inverter should be installed upright on a vertical surface.

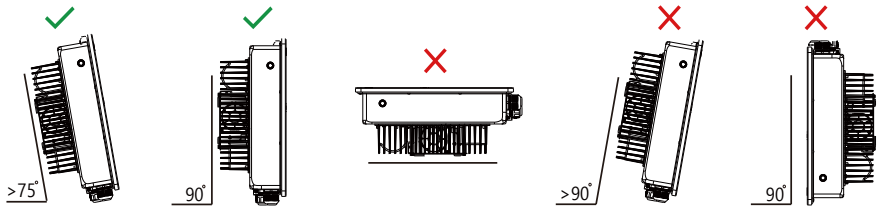

2.5.2 Inverter Mounting

Step 1. Use the mounting template (cardboard) to mark the positions of the three mounting holes, then drill holes with a diameter of 8 mm and a depth greater than 50 mm.

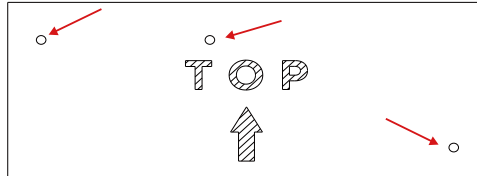

Step 2. Align the wall-mount bracket with the mounting holes, insert the expansion bolts into the holes, and tighten them. Then pre-fix the supplied L-shaped wall bracket to the wall using the expansion screws.

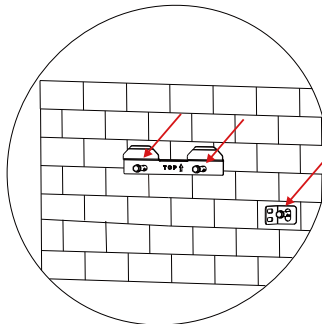

Step 3. Hang the inverter onto the bracket, and then secure the side L-shaped wall bracket to the inverter.

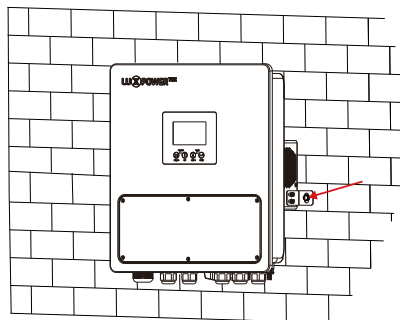

2.6 Battery Connection

Wiring instructions

Note: For the final installation, circuit breakers complying with IEC 60947-1 and IEC 60947-2 standards must be equipped and installed together with the device.

● NOTICE

Before Wiring

- All wiring work must be carried out by qualified professionals to avoid the risk of electric shock.
- Using proper AC input cables is critical for system safety and efficient operation. To reduce the risk of injury, please use the cable specifications recommended in this manual.
- Before performing any wiring operations, remove the bottom cover of the inverter (by loosening the 6 screws shown in the diagram).
- Ensure the inverter is completely powered off before removing the cover.
- Double-check the polarity of all DC cables during wiring.
- Strictly follow the recommended cable sizes and specifications. Incorrect wiring may cause overheating or fire hazards.
- Ensure that all terminals are tightened according to the recommended torque. Loose connections may result in malfunction or damage.

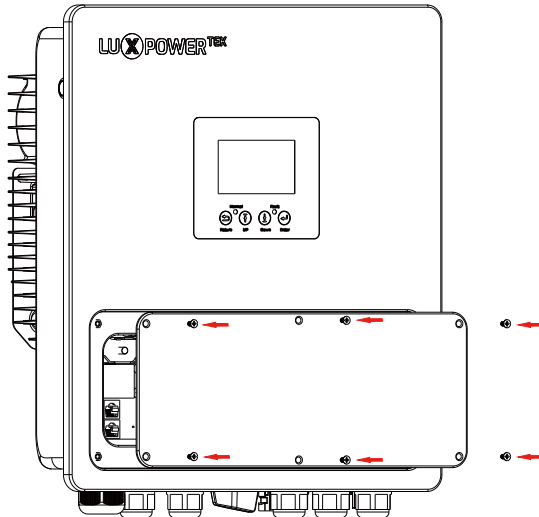

2.6.1 Recommended battery cables and breaker specifications

● NOTICE

- The cable insulation rating should not be lower than 90 °C.
- Keep the cable length as short as possible to reduce voltage drop.
- The wiring sequence should be: connect the positive (+) terminal first, then the negative (-) terminal.

Model	Breaker Specification	Cable Size	Torque (N·m)	Compatible Cable Hole
SNA PRO-EU 3-6.5K	150A / 80V DC	1/2 AWG	4-5 N·m	M6

Note:

Battery terminal screw: M6

2.6.2 General safety notes

- A proper DC breaker or isolating switch must be installed between the inverter and the battery. Polarity must be strictly observed during wiring.
- All terminals must be tightened according to the recommended torque to avoid overheating caused by poor contact.
- Use extreme caution when working with metal tools around batteries. Dropped tools may cause sparks, short circuits, or even explosions.

2.6.3 Lead-Acid battery connection

When using lead-acid batteries, please follow the requirements below:

- The recommended charging current is 0.2C (C = battery capacity).
- Battery cables must comply with the recommended cable specifications (see table above).
- Properly install ring terminals, and tighten all bolts with a torque of 4-5 N·m.
- Before starting the inverter, double-check that the polarity is correct.

2.6.4 Lithium battery connection

When using lithium batteries, ensure the battery BMS is compatible with Luxpower inverter (refer to the latest compatibility list on the Luxpower official website).

Operating Procedures:

Step 1: Assemble the battery ring terminals and connect the power cables between the inverter and the battery according to the recommended specifications (refer to the table above).

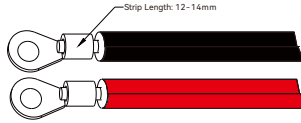

Step 2: Insert the battery cables with pre-crimped ring terminals straight into the inverter's battery connection ports. Ensure that the bolts are tightened to a torque of 5 N·m ($\pm 10\%$). Make sure the battery polarity is correctly connected.

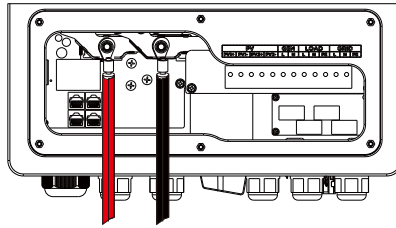

2.6.4 Battery communication cable connection

Operating Procedures:

Step 1: Loosen the COM gland nut on the inverter casing, and remove the sealing plug from the cable gland as required. Do not remove the sealing plug from any unused cable entry ports.

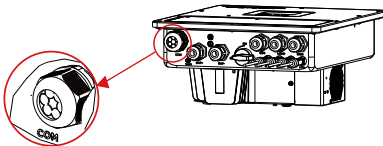

Step 2: Pass the battery communication cable sequentially through the gland nut, cable gland, and connector housing.

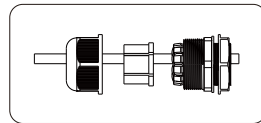

Step 3: Insert the RJ45 connector into the inverter's internal battery communication port. Finally, tighten the gland nut to ensure a firm and sealed connection.

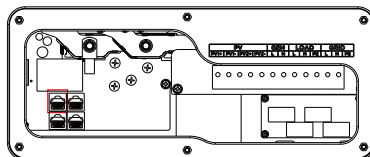

Step 4: If the manufacturer does not provide a dedicated communication cable, crimp the cable yourself according to the PIN definition.

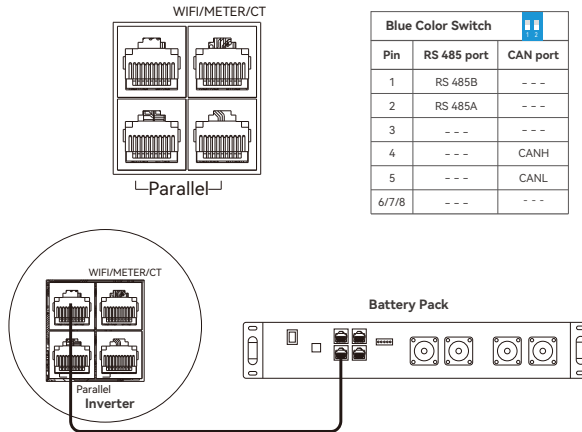

Step 5: Configure the battery type via the LCD:

- a. Go to “Common” → Select “Lithium battery”.
- b. In the menu, choose the correct battery brand/model (refer to the Luxpower battery compatibility list).

Example:

- a. Luxpower battery → Select Type 6: Luxpower.
- b. Hina battery → Select Type 1: Hina.

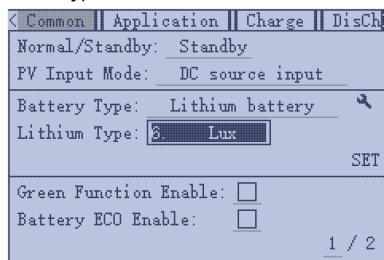

Notes for third-party lithium batteries:

- a. Confirm whether the communication protocol (CAN/RS485) is compatible.
- b. Some batteries may require setting DIP switches or brand IDs.
- c. If communication fails, the system will fall back to voltage control mode (SOC/temperature will not be displayed).
- d. Always refer to the battery manufacturer’s manual during installation.

2.7 Ground Cable Connection

To ensure electrical safety and proper system grounding, please follow the steps below to install the ground cable to the inverter chassis.

NOTICE

- When using multiple inverters in parallel, all chassis ground cables must be connected to the same grounding point to avoid potential voltage differences.
 - The chassis ground does not replace the PE cable of the AC output. Both connections must be made separately.
 - If local standards require equipotential bonding, use a dedicated grounding busbar to connect PV module frames, racks, and other components accordingly.
- ▲ **WARNING:** Improper grounding may cause electric shock hazards or equipment malfunction. Always comply with local electrical codes and standards.

Name	Cable	Cable Size (mm ²)	OT Terminal	Torque (N·m)
Ground cable	Single-core copper wire (solid or stranded)	6 mm ²	M4	2.0 N·m

Installation Procedures

Step 1: Strip the grounding wire, insert it into the OT terminal, and use a crimping tool to secure it firmly.

Step 2: Use a torque wrench to fasten the OT terminal to the inverter grounding port with a recommended torque of 1.2 N·m (±10%).

Step 3: Verify that all grounding terminals are firmly secured and that wires are not loose.

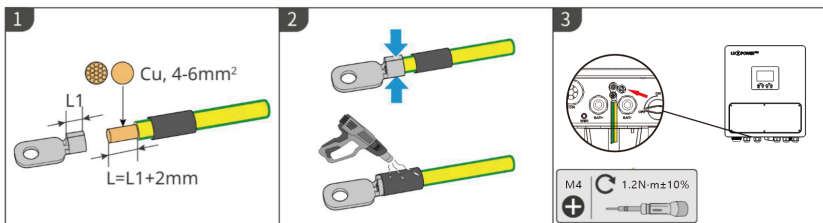

2.8 AC Input/Output Connection

⚠ CAUTION

- The AC terminals are divided into IN (input) and OUT (output). Do not connect them incorrectly.
- Ensure correct L (Live) and N (Neutral) polarity. Reversed polarity may cause short circuits, especially in parallel operation.
- Before performing AC input/output wiring, make sure the AC power is completely disconnected to avoid the risk of electric shock.

⚠ The AC Output Port must not be connected to any type of transformer:

- Connecting a transformer may cause abnormal operation of the inverter's internal circuits, potentially leading to overload, damage, or safety hazards.
- Only connect household appliances or loads within the rated power.
- For extended applications, strictly follow the official installation guidelines and consult technical support.

Recommended cable size for GRID/LOAD/GEN and PE wiring are listed below.

Model	GRID/LOAD/GEN Gauge	Cable Size (mm ²)	Torque Value
SNA PRO-EU 3-6.5K	10 AWG	6 mm ²	2.0 N·m

Model	PE Gauge	Cable Size (mm ²)	Torque Value
SNA PRO-EU 3-6.5K	12 AWG	4 mm ²	2.0 N·m

Wiring Procedures (for Input and Output)

Step 1: Turn off the DC protection switch.

Step 2: Strip 10 mm of insulation from the wires.

Step 3: Insert the stripped wires into the AC terminals and tighten the screws with the recommended 2.0 N·m torque.

Step 4: Connect the PE ground wire first, then L and N.

Step 5: Check that all wires are firmly secured.

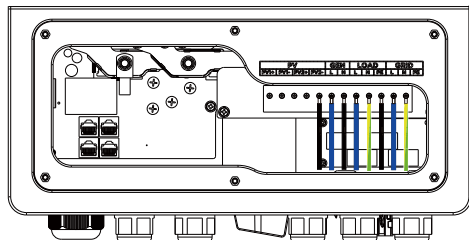
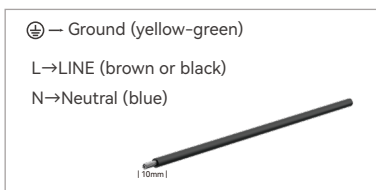

Step 6: Always connect the PE ground wire first, followed by L (Live) and N (Neutral).

Step 7: Check that all wires are firmly connected to ensure there is no looseness.

Additional Notes

Both the GRID and LOAD sides must be connected through 50 A circuit breakers — the input side to the grid, and the output side to household loads (EPS / backup).

Distribute loads reasonably and ensure reliable grounding for system safety.

2.9 CT Connection

The CT is used to measure the input and output power of the grid. It must be installed at the main incoming switch or close to the main distribution box.

- The external grid CT function is disabled by default. If power feedback is required, enable it via LCD → Advanced Settings → External Grid CT.
- Incorrect CT installation may result in inaccurate power measurements, which can affect inverter functionality and display data.

2.9.1 CT Port definition

The CT port uses an RJ45 connector.

Pin definition is as follows:

Pin	Description
	CT
1/2	WIFI
3/4	Meter
5	CTN
6	CTP
7	CTN
8	CTP

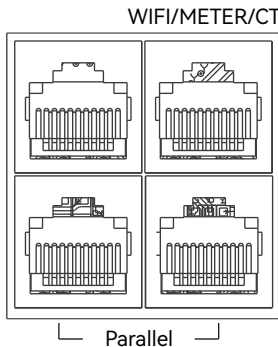

2.9.2 Installation precautions

- The CT arrow must face toward the inverter.
- If the installation direction is incorrect, you can adjust it via LCD → Advanced Settings → CT Direction Reverse, without changing the physical wiring.
- Ensure that the CT clamp is securely fastened around the cable.

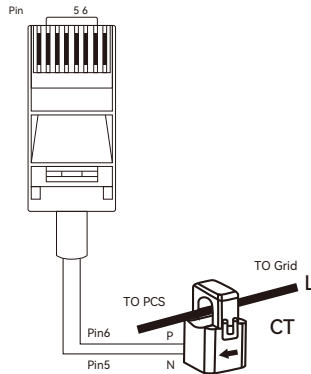

2.9.3 CT ratio

- Supported CT ratios: 1000:1, 2000:1, 3000:1.
- The CT included in the accessory package has a default ratio of 1000:1.
- When using a third-party CT, ensure that its ratio is one of the above and configure it correctly in the LCD menu or monitoring platform.

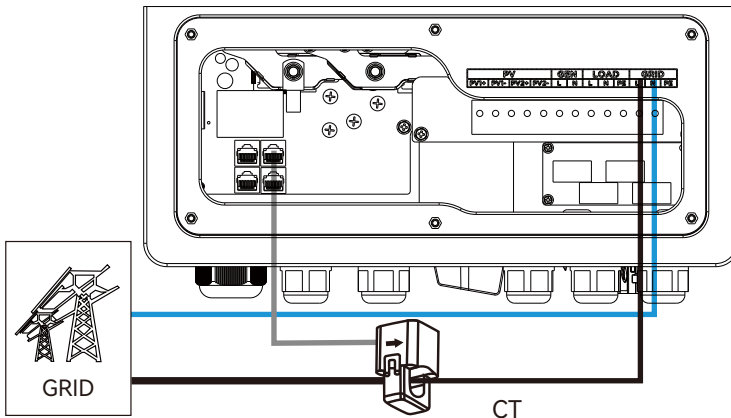

2.10 PV Connection

2.10.1 Recommended cables and breaker specifications

Model	DC Breaker	Cable Type	Cable Size (mm ²)	Torque Value
SNA PRO-EU 3-6.5K	600 V / 25 A	1 × 10 AWG	6 mm ²	2.0 N·m

Wiring Procedures

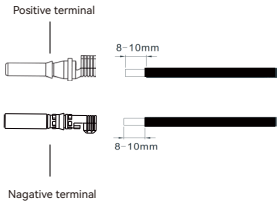
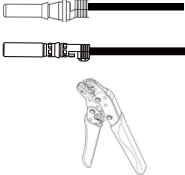
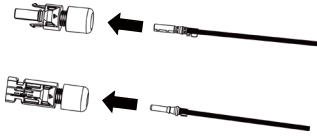
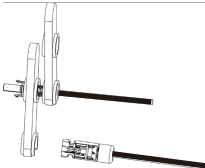
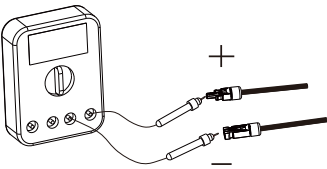
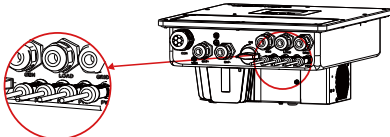
<p>1. Remove the insulation layer from the cable and install the cold-pressed terminal.</p>  <p>Positive terminal</p> <p>8-10mm</p> <p>Negative terminal</p> <p>8-10mm</p>	<p>2. Utilize a crimping tool to crimp the terminal ensuring that the cable cannot be pulled out after crimping.</p> 
<p>3. Securely assemble the cable into the positive and negative terminal shells.</p> 	<p>4. Tighten the sealing nut.</p> 
<p>5. Check the polarity of the photovoltaic string cable and ensure that the highest voltage does not exceed 500V.</p> 	<p>6. Confirm that all DC switches are in the "OFF" position, then insert the PV connector into the corresponding PV terminal in the inverter's PV input wiring area.</p> 

● NOTICE

- Do not connect PV modules that may pose a leakage risk to the inverter. For example, grounded PV modules can cause inverter leakage. Ensure that the PV+ and PV- terminals of the PV array are not connected to the system grounding bar.
- It is strongly recommended to use a PV combiner box with surge protection. Without it, lightning strikes may damage the inverter.
- A dedicated DC circuit breaker (600 V / 25 A) must be installed between the PV modules and the inverter.
- Cables must be UV-resistant, double-insulated, and designed for outdoor PV applications.
- Ensure that cable voltage drop does not exceed 2%. If the cable length is too long, increase the conductor size accordingly.
- It is strongly recommended to install a DC isolator switch compliant with IEC 60947-3 or equivalent standards to enhance operational safety.

2.11 GEN Port Function

● NOTICE

1. The GEN port is a multifunctional interface that can be configured for one of the following three application modes:

- a. Generator Connection
- b. Smart Load
- c. AC Coupling

These three functions are mutually exclusive. Only one function can be selected for actual use; they cannot be used simultaneously.

2. The generator must be connected to the GEN port through a dedicated circuit breaker to ensure safe operation. It is recommended to use a circuit breaker compliant with IEC 60947-1 / IEC 60947-2 standards, with a typical rating of 50A/2P. The breaker size may be adjusted according to the rated power of the generator.

2.11.1 Generator Connection

2.11.1.1 Generator system connection

This product supports generator connection through the GEN port for both battery charging and household load supply. In the event of a grid outage, the generator can serve as a backup power source to ensure continuous system operation.

- When selecting a generator, ensure sufficient capacity and stable frequency (Total Harmonic Distortion THD < 3%).
- It is recommended that the generator's rated output power be at least 1.5 times the inverter output power to meet both load supply and battery charging requirements.
- The table below lists the recommended generator capacities corresponding to the number of parallel inverters:

Number of inverters in parallel	Generator Capacity
1	>10kW
2	>15kW
3	>20kW
4	25kW

2.11.1.2 Wiring Instruction

This SNA Pro series can work with a generator and includes a dedicated Gen port for generator connection.

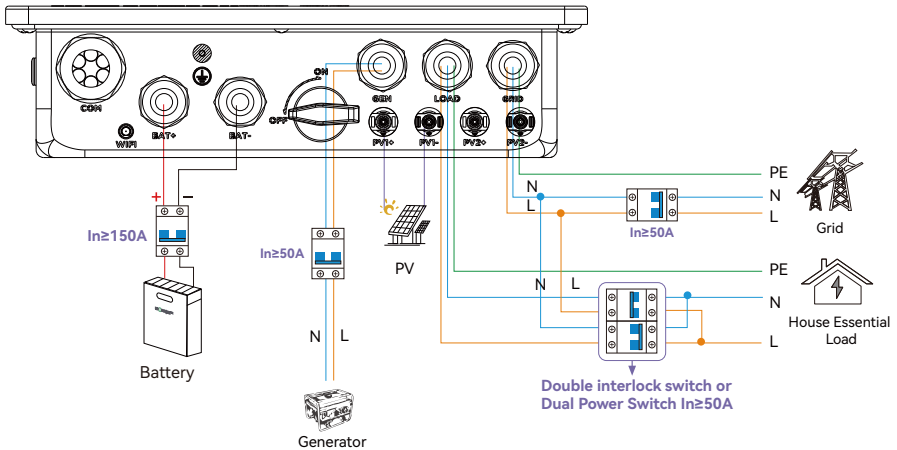

Operating Procedures

Step 1: Ensure that both the inverter and generator are powered off, and all circuit breakers are in the off position.

Step 2: Identify and connect the GEN wiring according to wiring specifications:

- L (Line): Black or brown
- N (Neutral): Blue
- PE (Protective Earth): Yellow-green

Step 3: Connect the L line to the corresponding GEN terminals on the inverter, and connect the N line to the N terminal of the GEN port.

When properly wired and configured, the generator, if compatible with remote start, will start automatically when the battery voltage / SOC is lower than the cut-off value or there is a charge request from the BMS. When the generator is running, it will charge the batteries and excess AC power will be diverted to the AC output (LOAD) to power loads.

2.11.1.3 Integrated two-wire Start/Stop

The generator start signal shall be connected to the COM board GEN Nominal Open (NO and COM), or Nominal Close (NC and COM) port, if users want to start generator remotely.

NOTICE

NO: Normal open NC: Normal close
 Gen Port Relay/Dry Port Relay Maximum Specification: 277VAC 3A

Unit Status	Condition			
			NO & COM	NC & COM
Power Off	Inverter is off and no output is powered.		Open	Close
Power On	Without Grid	Battery voltage/SOC < Generator Charge Start Voltage/SOC	Close	Open
		Battery voltage/SOC > Generator Charge End Voltage/SOC	Open	Close
	With Grid	Battery voltage/SOC < Generator Charge Start Voltage/SOC	Open	Close
		Battery voltage/SOC > Generator Charge End Voltage/SOC	Open	Close

2.11.1.4 Generator Start and Stop settings

Start Conditions:

The generator will start when utility fails and one of the following conditions is met:

- Battery voltage is below the configured cutoff voltage.
- BMS issues a charge request.
- Battery voltage or SOC is below the “Generator Charge Start SOC/Volt” and within the generator’s configured charging time.
- One-touch generator start command issued via monitoring platform.

Stop Conditions:

- Battery voltage or SOC exceeds the “Generator Charge End SOC/Volt”.
- Charging time exceeds the generator’s configured range.
- Charging completion setting has been reached.
- One-touch generator start: after a 20-minute exercise run, the generator will automatically shut down.

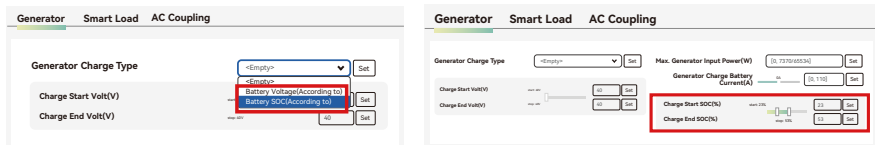

Gen Time

	Start		End
T1	00 : 00 [Set]	█	00 : 00 [Set]
T2	00 : 00 [Set]	█	00 : 00 [Set]

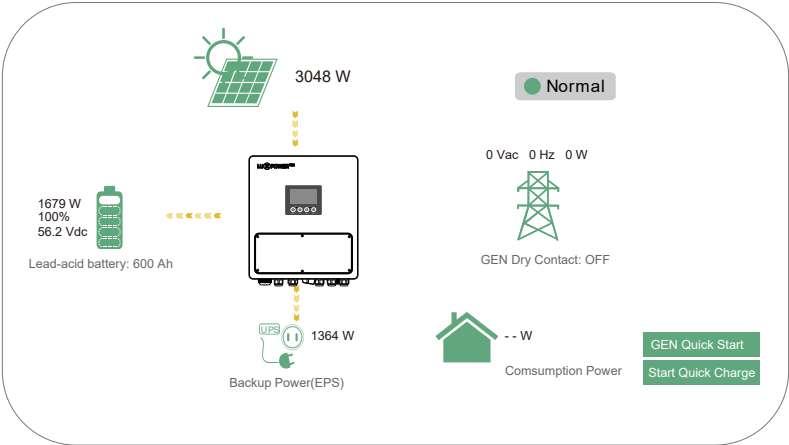

2.11.1.5 Generator Charging Mode settings

Users can select the generator charging logic via the monitoring platform or the LCD interface:

- By Voltage and Time: Recommended for lead-acid batteries.
- By SOC (State of Charge) and Time: Recommended for lithium batteries.

Configurable Parameters Include:

- Start/stop voltage or SOC.
- Generator charging time 1 and charging time 2.
- Maximum charging current.
- Maximum generator input power.

2.11.1.6 Gen Boost function

The GEN Boost function is used when the generator power is insufficient to supply the entire load. In this case, the PV system and battery jointly provide supplementary power to ensure stable operation. When enabled, the system reserves a certain power margin for the generator to avoid frequent fluctuations that could cause overload, thereby extending generator lifespan and improving reliability.

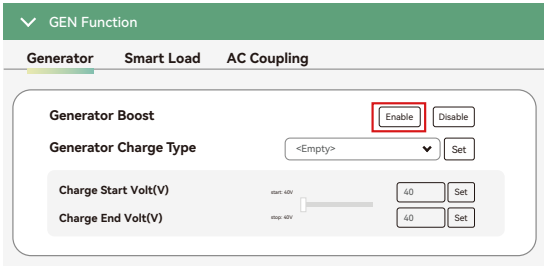

2.11.2 Smart load

2.11.2.1 Function overview

The Smart Load function automatically activates designated loads (such as water heaters or EV chargers) when battery energy is sufficient and PV generation is surplus. This improves the utilization of clean energy and prevents resource waste.

When battery energy is low or generation decreases, the system automatically disconnects the smart load to prioritize continuous power supply to essential household loads.

2.11.2.2 Wiring instructions

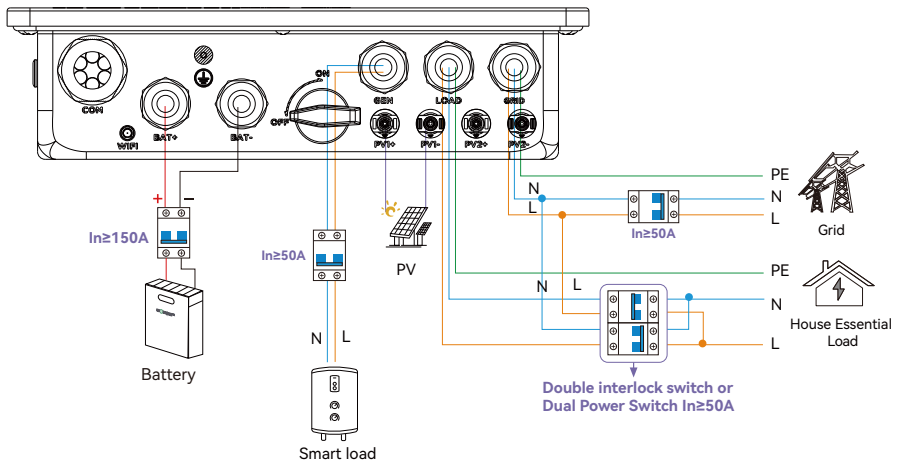

Operating Procedures

Step 1: Ensure that both the inverter and external loads are powered off, and all circuit breakers are in the off position.

Step 2: Identify and connect the smart load wiring according to wiring specifications:

- L (Line): Black or brown
- N (Neutral): Blue
- PE (Protective Earth): Yellow-green

Step 3: Connect the smart load's L and N wires to the corresponding L and N terminals on the GEN port, and connect the load's PE wire to the inverter's grounding terminal.

Step 4: It is recommended to install a dedicated circuit breaker for the smart load branch (e.g., 50A / 2P or compliant with IEC 60947 standards) to ensure safe operation.

2.11.2.3 Smart Load Settings

Enable smart load

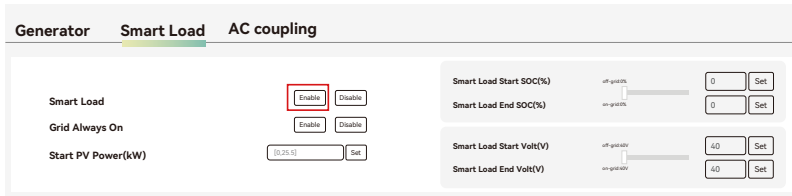

Enable “Grid always on”: When connected to the grid, the smart load remains continuously connected. Start PV Power: Input the PV power threshold at which you want the smart load to start. You can also input the battery’s SOC or voltage to select when to start and stop.

2.11.2.4 Example applications

- Automatically start a water heater when PV generation is sufficient.
- Enable EV charging after the battery is fully charged.
- Run high-power household appliances during off-peak periods using remaining energy.

2.11.3 AC Coupling

2.11.3.1 Function overview

The AC Coupling function allows users to integrate an existing on-grid inverter system through the GEN interface, thereby upgrading the system into a hybrid energy storage system.

- When the utility grid is disconnected, this inverter automatically switches to off-grid mode, maintaining stable system voltage and frequency, and enables the on-grid inverter to continue generating power via the GEN interface.
 - When PV power is sufficient, the inverter prioritizes load supply and uses surplus energy to charge the battery.
 - Once the battery is fully charged, the inverter will limit the output power of the on-grid inverter.
 - When PV power is insufficient, both the battery and the on-grid inverter will supply power jointly to ensure uninterrupted operation of critical loads.
- When the utility grid is available, this inverter and the on-grid inverter operate in coordination. Solar energy can simultaneously power loads and charge the battery. When load demand is low or the battery is fully charged, excess energy can be exported to the grid, ensuring optimal energy utilization.

● NOTICE

When using the AC Coupling function while the grid is available, ensure that the system has proper grid connection authorization and fully complies with local grid interconnection regulations.

2.11.3.2 Wiring instructions

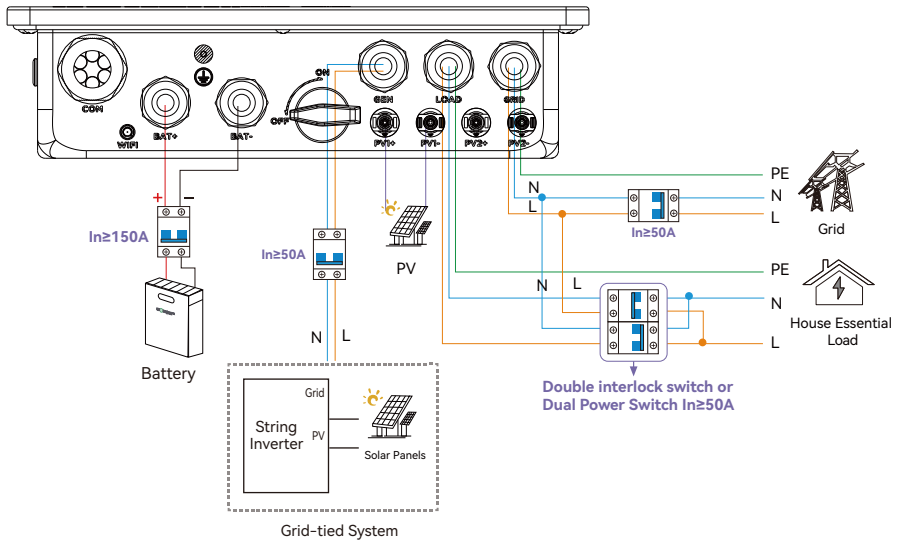

Operating Procedures

Step 1: Ensure that the inverter, grid-tied inverter, and the grid are all powered off, with all circuit breakers in the off position.

Step 2: Connect the output terminals of the grid-tied inverter (L, N, PE) to the corresponding GEN port on this inverter:

- a. L (Line) → GEN port L
- b. N (Neutral) → GEN port N
- c. PE (Protective Earth) → Inverter grounding terminal

Step 3: It is recommended to install a dedicated circuit breaker in the AC Coupling loop to ensure safe operation.

The AC Coupling setting must be enabled when connecting an existing on-grid system to the GEN port.

- Start SOC(%): The SOC at which the AC-coupled inverters are turned on when in off-grid mode (50% recommended).
- End SOC(%): The SOC at which the AC-coupled inverters are shut down when in off-grid mode (90% recommended).

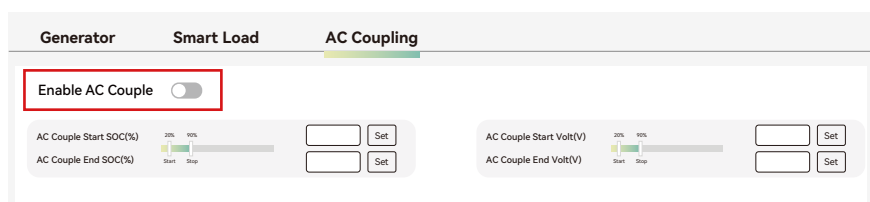

2.11.3.3 System features

- **Grid-Tied Mode:** The grid-tied inverter continuously operates, feeding PV-generated electricity directly into the grid. Any excess energy can be sold back to the grid.
- **Off-Grid Mode:** The grid-tied inverter operates using a virtual grid signal provided by this inverter. The generated energy can be used to charge the battery or supply loads.
- **Energy Priority:** PV generation supplies the load first. Remaining energy is used to charge the battery. When battery energy is insufficient, the system automatically switches to grid power.

2.11.3.4 Export to Grid

When the grid is available, to feed surplus energy from an AC coupled inverter into the grid, the “Export to Grid” function must be enabled in the settings interface.

When enabled, the AC coupled inverter will feed unused energy back to the grid, maximizing energy utilization.

When disabled, surplus energy is only used for battery charging or local loads and cannot be exported to the grid.

Before enabling, confirm that the local utility allows surplus energy export and strictly comply with relevant grid-connection policies and standards.

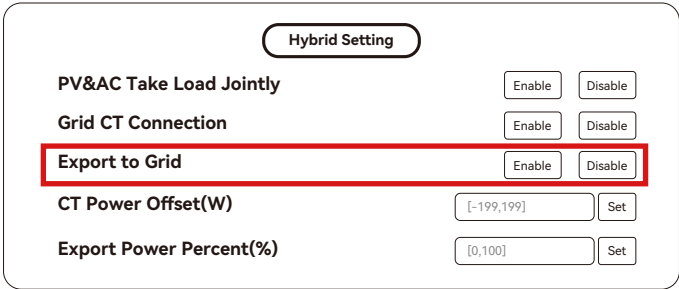

2.12 Parallel Function

SNA series inverter support up to 16 units to composed single phase parallel system or three phase parallel system, for parallel system setup.

● NOTICE

- Each inverter must have its own dedicated PV input; PV inputs cannot be shared.
- All parallel cables must be connected according to the instructions to ensure signal transmission and system stability.
- Before parallel operation, ensure all inverters have the same firmware version and that parallel parameters are configured.

System Wiring Diagram:

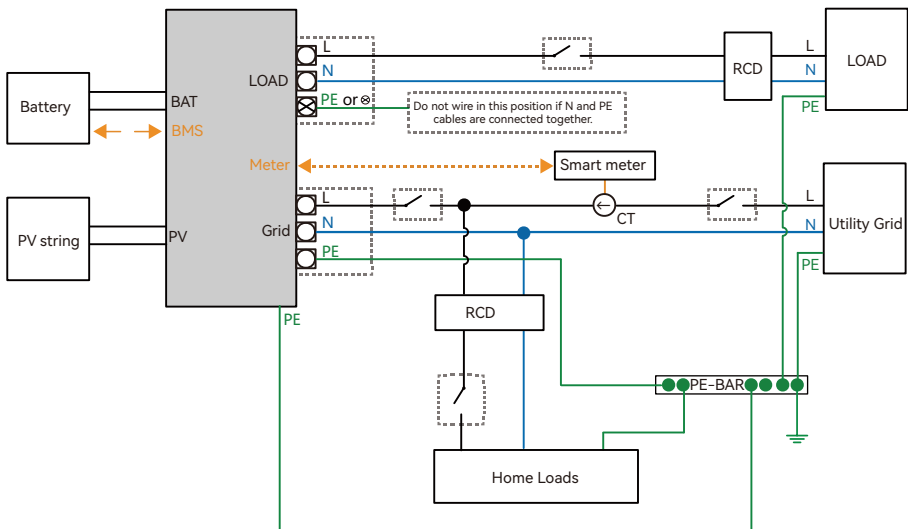

● NOTICE

The PE line of the load must be correctly and effectively grounded. Otherwise, backup functions may not operate properly during grid faults.

2.12.1 Single phase parallel connection diagram

⚠ Cannot share PV input at any time!

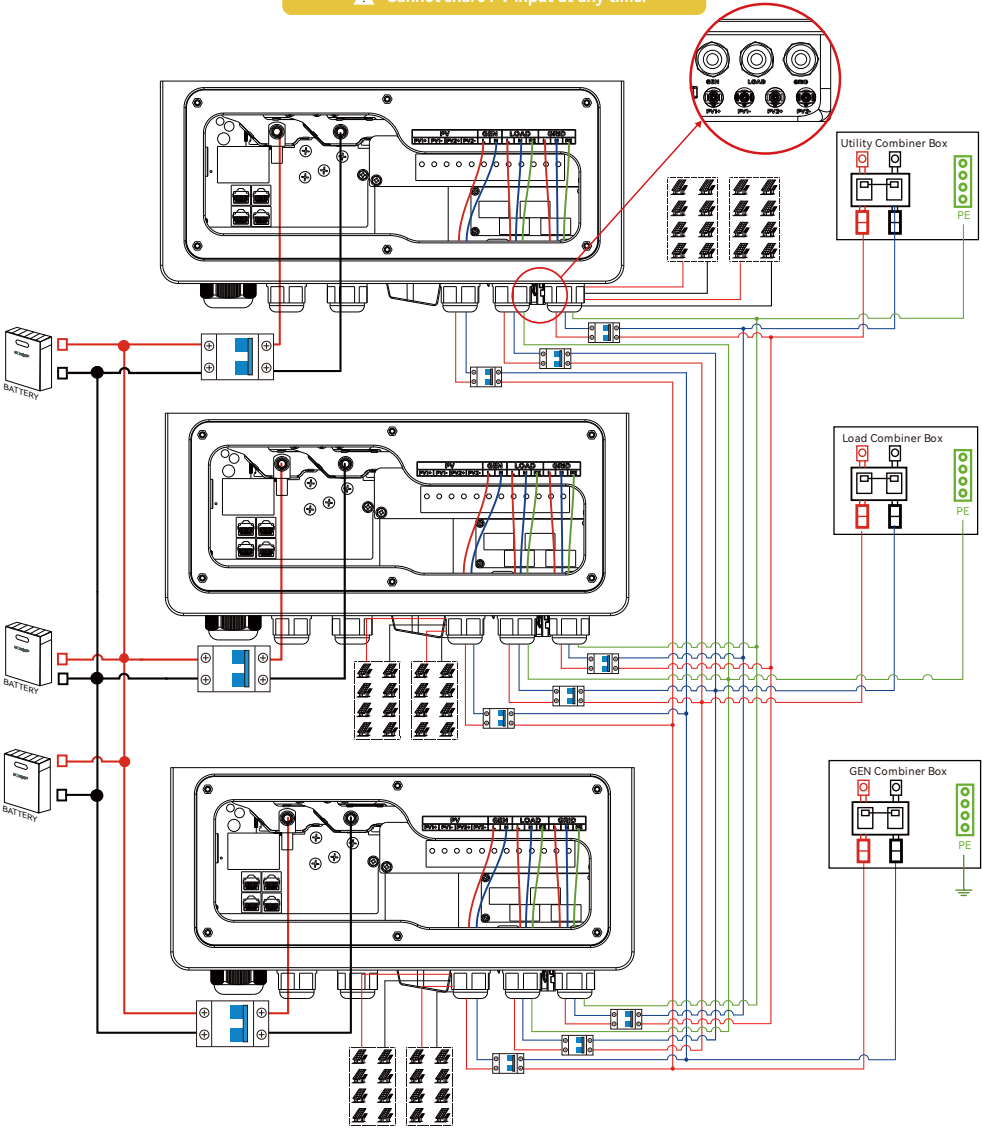

2.12.2 Three phase parallel connection diagram

⚠ Cannot share PV input at any time!

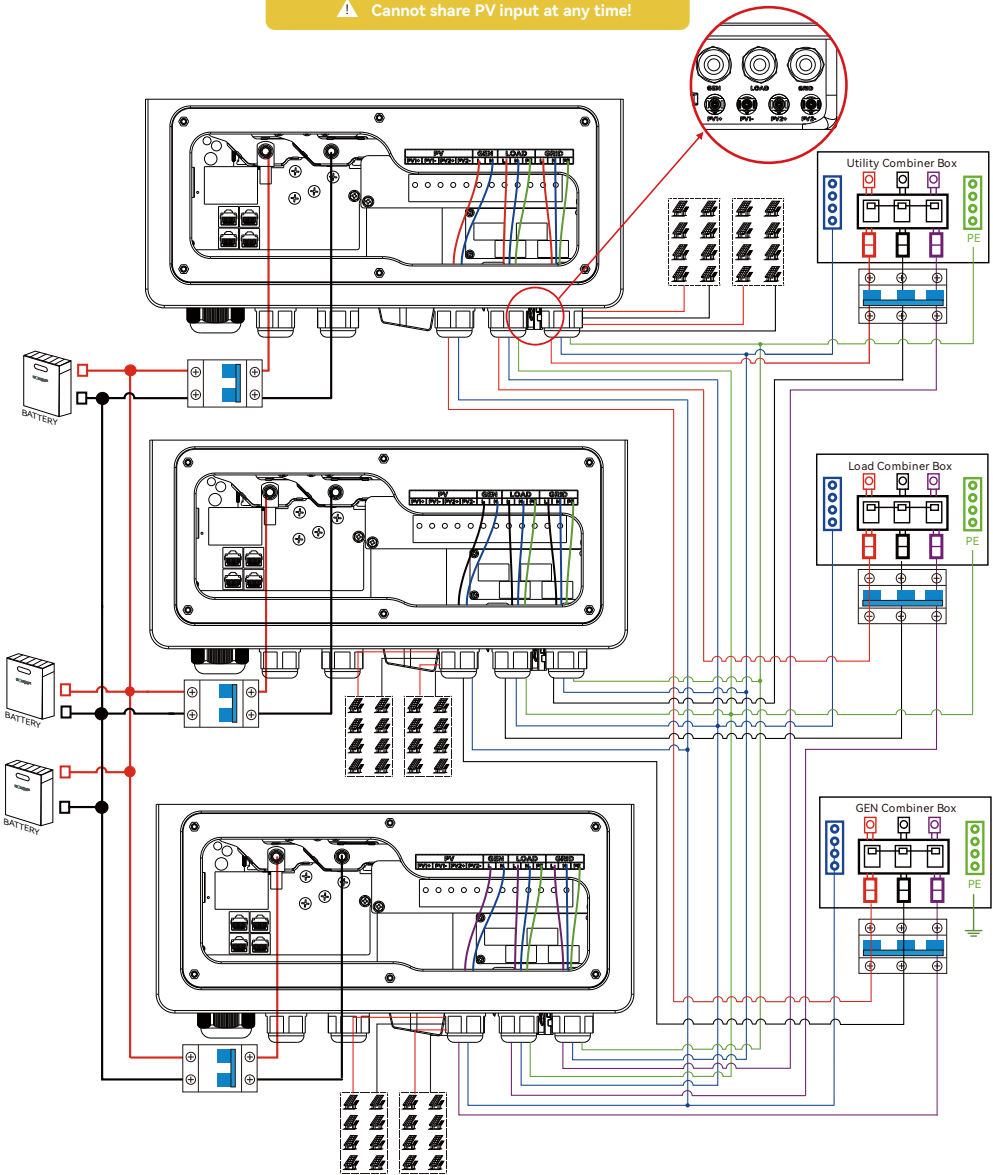

2.12.3 Dip Switch

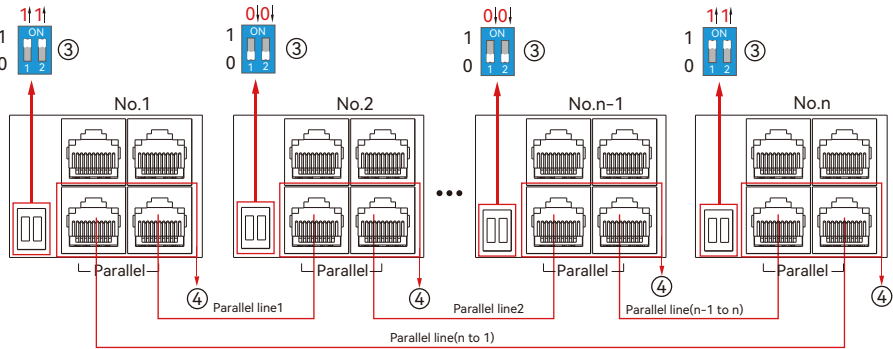

The max parallel quantity is 16, so $2s \leq n \leq 16$

2.12.4 Monitoring settings

Operating Procedures

Step 1: Setup the monitor for the system, add all dongles in one station. Users can login to the visit interface of monitor system, Configuration->station->Plant Management->add dongle to add the dongles.

Plant name	Installer	End User	Country	Timezone	Daylight saving time	Create date	Action
1 Genesis		Aspergo Install	South Africa	GMT+2	No	2019-03-14	Station Management
2 Butler Home	Elangeni	johnbutler	South Africa	GMT+2	No	2019-03-25	Station Management
3 Office			South Africa	GMT+2	No	2019-06-03	Station Management
4 Cronje Home	Broomhead	cronje	South Africa	GMT+2	No	2019-07-16	Station Management

Step 2: Enable share battery for the system if the system share one battery bank, otherwise disable the shared battery function.

Parallel Setting

Set System Type (?) <Empty> V | Set

Share Battery (?) Enable | Disable

Set Composed Phase (?) <Empty> V | Set

Step 3: Set the system as a parallel group in the monitor system.

Serial number	Status	Solar Power	Charge Power	Discharge Power	Load	Solar Yield	Battery Dischar	Feed Energy	ConsumptionEr	Station name	Parallel	Action
1	Normal	228 W	42 W	0 W	182 W	215.3 kWh	39.6 kWh	0 kWh	551.2 kWh	Dragonview	A-1	Parallel
2		35 W	32 W	0 W	0 W	158.7 kWh	21.1 kWh	0 kWh	160.5 kWh	Dragonview	A-2	Parallel
3		1 kW	129 W	0 W	1 kW	170.3 kWh	49.9 kWh	0 kWh	434.5 kWh	Dragonview	A-3	Parallel
4		79 W	48 W	0 W	106 W	99 kWh	85.6 kWh	0 kWh	257.1 kWh	Dragonview	A-4	Parallel

For more detailed guidance for paralleling system, please visit <https://www.luxpowertek.com/download/> And download the guidance.

2.13 Power Switch and PV Switch

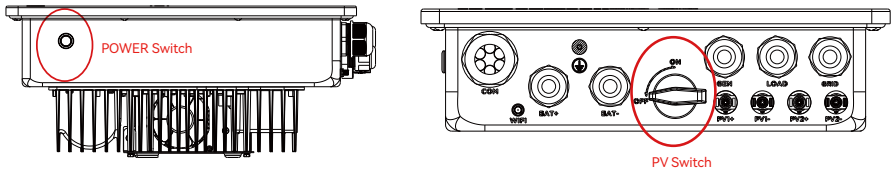

Power Switch: Control the overall power supply of the unit.



PV Input Switch: Control the input from the PV source.

After completing all wiring connections, turn both switches ON. In an emergency, the user may turn OFF the PV Input Switch to disconnect the PV power source.

3. Working Modes

3.1 SNA Series inverter modes introduction:

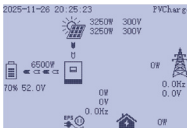
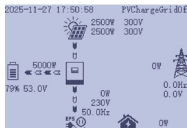
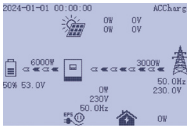
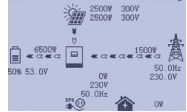
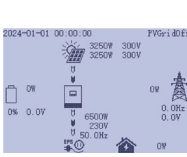
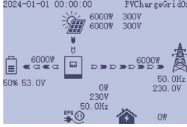
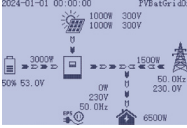
<p>Bypass Mode</p>		<p>AC is used to take the load.</p>
<p>PV Charge Bypass</p>		<p>PV charge the battery while the AC power the load.</p>
<p>BAT Grid off</p>		<p>Battery is used to take the load.</p>
<p>PV+BAT Grid off</p>		<p>PV+Battery power the load together.</p>

<p>PV Charge</p>	 <p>2025-11-26 20:25:23 PVCharge 3250W 300V 3250W 300V 6500W 70% 52.0V 0V 0.0Hz 0V 0.0Hz 0V 0.0Hz EPS ON Home OFF</p>	<p>1. When the EPS key off, the inverter charge the battery only. 2. When the battery is power off, the PV can wake up the battery automatically.</p>
<p>PV Charge+Grid off</p>	 <p>2025-11-27 17:50:58 PVChargeGridOFF 2500W 300V 2500W 300V 6000W 79% 53.0V 0V 0.0Hz 0V 0.0Hz 50.0Hz EPS ON Home OFF</p>	<p>PV charge the battery and power the load.</p>
<p>AC Charge</p>	 <p>2024-01-01 00:00:00 ACCharge 0W 0V 0W 0V 6000W 50% 53.0V 0V 0.0Hz 230V 230.0V 50.0Hz EPS ON Home OFF</p>	<p>1. AC charge the battery from AC Input or GEN Input. 2. When the battery is power off, the AC can wake up the battery automatically</p>
<p>PV+AC charge</p>	 <p>2024-01-01 00:00:00 PVACCharge 2500W 300V 2500W 300V 6500W 50% 53.0V 0V 0.0Hz 1500W 230V 230.0V 50.0Hz EPS ON Home OFF</p>	<p>PV+AC charge the battery. AC is from AC Input or GEN Input.</p>
<p>PV Grid off</p>	 <p>2024-01-01 00:00:00 PVGridOFF 3250W 300V 3250W 300V 0W 0% 0.0V 0V 0.0Hz 0V 0.0Hz 50.0Hz EPS ON Home OFF</p>	<p>NOTE: The output power depends on the PV energy input, if the PV energy is unstable, witch will influence the output power. When you power off the battery, the PV will supply power to the load.</p>
<p>PV charge Grid on</p>	 <p>2024-01-01 00:00:00 PVChargeGridON 6000W 300V 6000W 300V 6000W 50% 53.0V 0V 0.0Hz 6000W 230V 230.0V 50.0Hz EPS ON Home OFF</p>	<p>PV charge battery and power the load. *The rest power from PV can feed in Grid.</p>
<p>PV+BAT Grid on</p>	 <p>2024-01-01 00:00:00 PV+BATGridON 1000W 300V 1000W 300V 3000W 50% 53.0V 0V 0.0Hz 1500W 230V 230.0V 50.0Hz 6500W EPS ON Home OFF</p>	<p>PV+Battery power the load, and the AC can power the load if PV+Battery power not enough.</p>
<p>PV Grid on</p>	 <p>2024-01-01 00:00:00 PVGridON 3000W 300V 3000W 300V 0W 0% 0.0V 0V 0.0Hz 6000W 230V 230.0V 50.0Hz EPS ON Home OFF</p>	<p>PV power the load, the rest power feed in Grid.</p>

3.2 Working Modes related setting description

Situation	Setting 1	Setting 2	Setting 3	Working modes and Description
AC abnormal	NA	NA	NA	off grid inverter mode if P_Solar>=P_Load, solar is used to take load and charge battery if P_Solar<P_Load, solar and battery take the load together, system will discharge until battery lower than the Cut Off Voltage / SOC.
		In the AC first time	NA	Hybrid Mode 1(charge first) Solar power will be used to charge battery first, The solar power will be used to charge the battery first. AC will take load. 1. 2. if solar power is higher than power need to charge the battery, the extra power will be used to take load together with grid. 3. if there is still more energy after charge battery and take the load, it will feed energy into grid if export to grid function is enabled.
	PV&AC Take Load Jointly Enable	Enable AC charge and in the AC charge time	AC charge according to Time	Hybrid Mode 1(charge first)>AC charge battery if solar power is not enough to charge battery.
			AC charge according to battery voltage or SOC	Hybrid Mode 1(charge first)>AC charge battery if solar power is not enough to charge battery and the battery voltage / SOC is lower than AC start charge voltage / SOC, the AC will stop charging when the battery Voltage / SOC is higher than AC end charge battery voltage / SOC.
AC normal		Not in the AC first time and disable AC charge or not in the AC charge time	NA	Hybrid Mode 2(load first) Solar power will be used to take load first, 1. if solar power is lower than load, battery will discharge together to take load until battery lower than EOD voltage / SOC. if solar power is higher than load, the extra power will be used to charge battery, if there is still 2. more energy, it will feed into grid if enable export.
		In the AC first time	NA	Bypass Mode AC will take the load and Solar is used to charge battery.
			AC charge according to Time	Bypass Mode>AC charge battery / Solar is used to charge battery. AC will take load and also charge battery during AC charge time if solar power is not enough.
	PV&AC Take Load Jointly Disable	Enable AC charge and in the AC charge time	AC charge according to SOC / Battery voltage	Bypass Mode>AC charge battery Solar is used to charge battery. AC will take load and also charge battery when battery SOC/Voltage is lower than start SOC / Voltage, and the AC will stop charging when the battery Voltage/SOC is higher than AC end charge battery voltage / SOC.
		Not in the AC first time and disable AC charge or not in the AC charge time	NA	off grid inverter mode if P_Solar>=P_Load, solar is used to take load and charge battery if P_Solar<P_Load, solar and battery take the load together, system will discharge until battery lower than EOD Voltage / SOC.

3.3 Hybrid Mode Function Overview

3.3.1 Function Description

The hybrid mode is an extended feature of the SNA off-grid inverter series, designed to provide more flexible power supply options for various application scenarios.

This function is mainly suitable for regions without mandatory grid-connection requirements, helping users maximize the synergistic advantages of solar power and battery storage. If your region has explicit or strict regulations regarding grid connection, do not enable this function to ensure that the system complies with local grid standards and safety requirements.

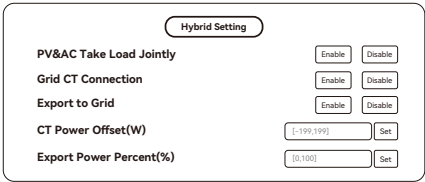

Related setting

PV & AC Take Load Jointly: Disabled by default. If there is no mandatory grid-connection requirement in your region, you can enable this feature to operate in hybrid mode.

Grid CT Connection: Enable this option if an external CT (current transformer) is connected.

Export to Grid: If there is no mandatory restriction on grid export in your area, you may enable this feature.

CT Power Offset: Allows you to enter a power calibration parameter to eliminate CT measurement errors, enabling more stable and accurate power control under anti-reflux or hybrid operation modes. Default value: 0 W

Adjustment range: typically ± 199 W

Recommended use cases:

If, under “Zero Export” mode, the monitoring system still displays slight “positive power (feedback),” set a negative offset (e.g., -50 W).

If the system continuously draws power from the grid, set a positive offset (e.g., +50 W) to help maintain a more accurate power balance point.

Export Power Percent: When “Export to Grid” is enabled in regions without mandatory grid restrictions, you can set an export power ratio.

3.4 Working Mode Overview

3.4.1 AC First

During the setting time, system will use AC to take load, use solar power to charge the battery first. If there is extra solar power, extra solar power will take the load. When out of the setting time, system will use solar and battery to take load first until battery voltage / SOC is lower than On Grid EOD settings, then it will use AC to take the load.



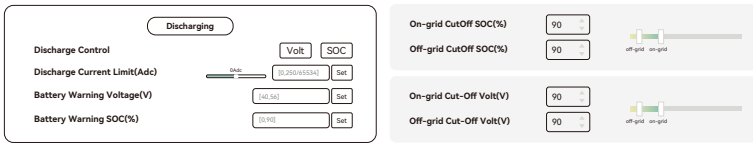

3.4.2 AC Charge

The system will not use AC to charge the battery (except when a forced charge command is issued by the lithium battery BMS).

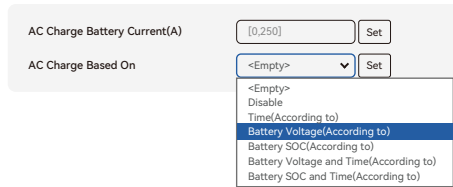

- According to Time: During the setting time, system will use AC to charge the battery until battery full and battery will not discharge during the setting time.
- According to Battery Voltage: During the setting voltage, system will use AC to charge the battery if battery voltage is lower than AC Charge Start Battery Voltage and will stop when Voltage is higher than AC Charge End Battery Voltage.
- According to Battery SOC: During the setting SOC, system will use AC to charge the battery if battery SOC is lower than AC Charge Start Battery SOC and will stop when Voltage is higher than AC Charge End Battery SOC.
- According to Battery Voltage and Time: During the setting time, system will use AC to charge the battery if battery voltage is lower than AC Charge Start Battery Voltage and will stop when Voltage is higher than AC Charge End Battery Voltage. And battery will not discharge during the setting time.
- According to Battery SOC and Time: During the setting time, system will use AC to charge the battery if battery SOC is lower than AC Charge Start Battery SOC and will stop when Voltage is higher than AC Charge End Battery SOC. And battery will not discharge during the setting time.

4. LCD display and settings

4.1 LED Display

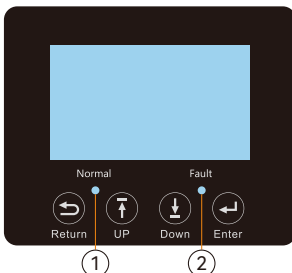

LED Indicator		Messages
1	Green	Solid On
	Flashing	Working normal
2	Red	Flashing
		fast: Warning slow: Firmware update
		Flashing
		Fault condition occurs in the inverter

4.2 LCD Display

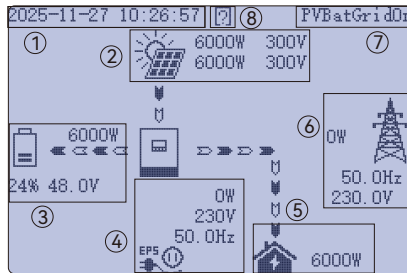

NO.	Description	Remarks
1	General Information Display Area	Displays the current time and date by default.
2	Solar inverter output power	Displays the load voltage, frequency, and power.
3	Battery information and data	Displays the battery type (lithium or lead-acid), battery voltage, SOC, and charge/discharge power.
4	PV Information and Data	Displays the real-time PV voltage and power of the two MPPTs.
5	Load consumption	Displays the power consumption of the loads in grid mode.
6	Grid information or Generator information	Displays the grid icon with real-time voltage, frequency, and input/output power information. If a generator is connected, the grid icon automatically switches to the generator icon and shows the generator's voltage, frequency, and input power.
7	Operating Status Display Area	This area shows the inverter's current operating status, including normal running messages, alarm codes, and error indications
8	WiFi Status	1) Not connected to the dongle.
		2) Connected to the dongle, but the dongle is not connected to WiFi. (No cloud/inverter connection)
		3) Dongle connected to WiFi, but not connected to cloud server. (No inverter connection)
		4) Dongle connected to WiFi and cloud server, but no communication with inverter.
		5) All connections are normal.

4.3 Inverter Status Display

When the SNA PRO inverter is running normally, the current operating status is shown in the highlighted area, such as “PVGridOn” or “PVCharge”

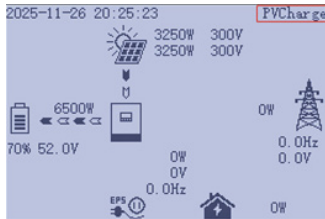

Warning Status, warning 01

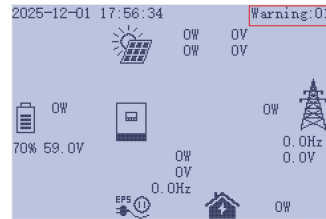

Fault status, fault 02



Flash status: download percent is 58%

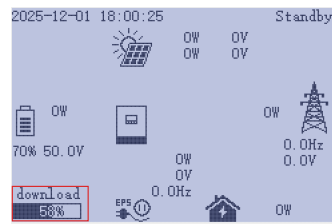

When the icon in the highlighted area is displayed, it indicates that the AC input port is connected to the power grid.

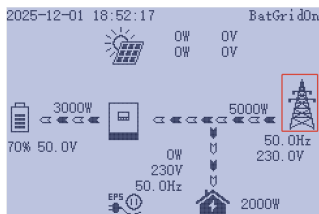

When the icon in the highlighted area is displayed, it indicates that the AC input port is connected to a generator.

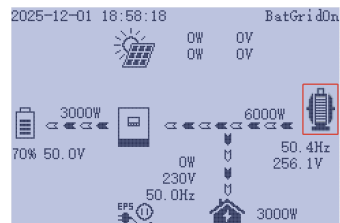

4.4 LCD Settings

Button Operations

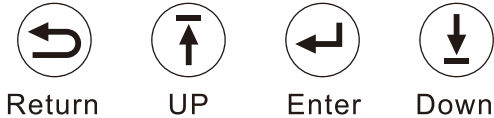

Button	Function
Return	Exit
Enter	Confirm, Enter menu
Up	Next step or Slide left
Down	Previous step or Slide right

Note: Long-pressing the **UP** and **DOWN** buttons will continuously input the corresponding key signals.

General Operations

Press **ENTER** on the home screen to access the menu options.

Using the **UP** and **DOWN** buttons, select the desired function, then press **ENTER** to enter.

Press **RETURN** to go back to the previous menu.

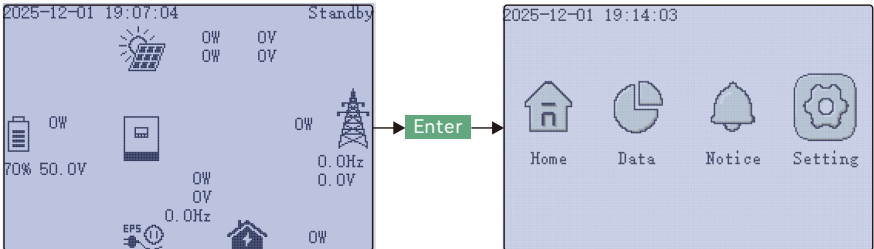

The available options include:

- Home** – main page
- Data** – operational data
- Notice** – fault and warning information
- Setting** – configuration settings

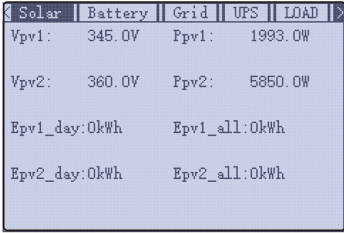
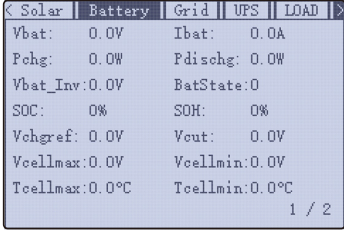
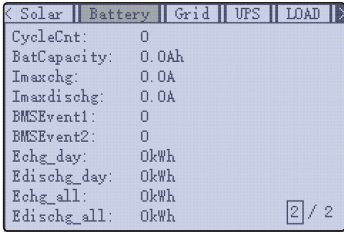

Note: Press the **UP** button repeatedly to scroll through the menu items in a loop: **Home** → **Data** → **Notice** → **Setting** → **Home**.

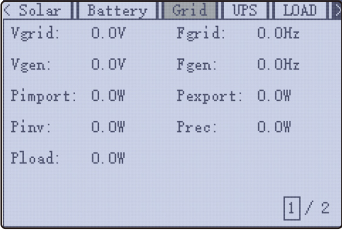
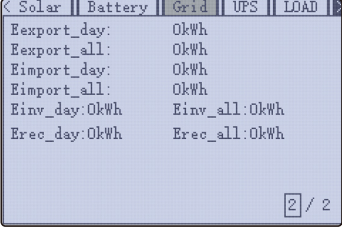
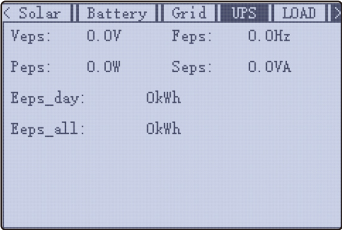
Index	Description	Data
1	Solar	 <p>The display shows the following information: PV1 voltage and power, PV2 voltage and power, Daily energy generation of PV1 and PV2, Total accumulated energy generation of PV1 and PV2.</p>
2	Battery (1)	 <p>The first battery page displays the following information: Battery voltage, Battery charge and discharge current, Charge power and discharge power, Inverter sampling battery voltage Battery status and remaining battery power, Battery health, Battery charge cut-off voltage and discharge cut-off voltage, Highest and lowest cell voltage, Highest and lowest cell temperature.</p>
3	Battery (2)	 <p>The second battery page displays the following information: Battery cycle count, Battery capacity, Maximum charge current and maximum discharge current, BMS event 1 and BMS event 2, Daily charge energy and total charge energy, Daily discharge energy and total discharge energy.</p>

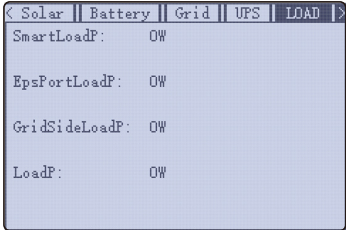
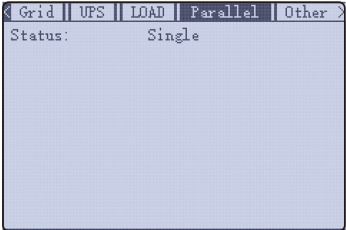
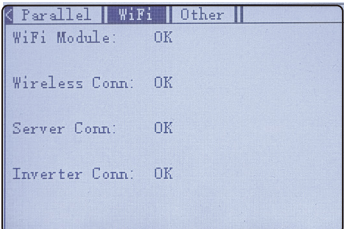
<p>4</p>	<p>Grid (1)</p>	 <pre> < Solar Battery Grid UPS LOAD > Vgrid: 0.0V Fgrid: 0.0Hz Vgen: 0.0V Fgen: 0.0Hz Pimport: 0.0W Pexport: 0.0W Pinv: 0.0W Prec: 0.0W Pload: 0.0W 1 / 2 </pre> <p>The first page displays the following grid-related information: Grid voltage and grid frequency, Generator voltage and generator frequency, Power imported from the grid to the inverter, Power exported from the inverter to the grid, Inverter power, Rectified power, Load power.</p>
<p>5</p>	<p>Grid (2)</p>	 <pre> < Solar Battery Grid UPS LOAD > Export_day: 0kWh Export_all: 0kWh Import_day: 0kWh Import_all: 0kWh Einv_day:0kWh Einv_all:0kWh Erec_day:0kWh Erec_all:0kWh 2 / 2 </pre> <p>The second page displays the following energy statistics: Daily and total energy exported to the grid; Daily and total energy imported from the grid; Daily and total inverter energy; Daily and total rectified energy.</p>
<p>6</p>	<p>UPS</p>	 <pre> < Solar Battery Grid UPS LOAD > Veps: 0.0V Feps: 0.0Hz Peps: 0.0W Seps: 0.0VA Eeps_day: 0kWh Eeps_all: 0kWh </pre> <p>The first page displays the following UPS-related information: Load voltage, Load frequency, Active load power, Apparent load power, Daily load energy, Total load energy.</p>

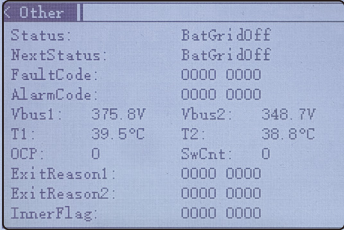
<p>7</p>	<p>LOAD</p>	 <p>This page displays the following information: Smart Load power, EPS port load power, Grid-side load power, Total load power.</p>
<p>8</p>	<p>Parallel</p>	 <p>This page displays the parallel configuration information, including: The inverter's role in the parallel system (primary or subordinate), Parallel type (single-phase or three-phase), Parallel phase (R, S, or T), Number of inverters in parallel, Parallel address.</p>
<p>9</p>	<p>WIFI</p>	 <p>This page displays the WiFi dongle status, including: WiFi module status, Wireless connection status, Server connection status, Inverter communication status.</p>

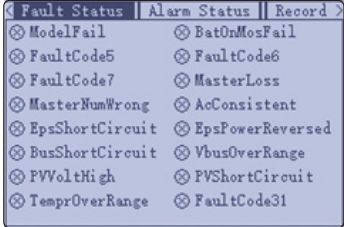
10	Other	 <p>This page displays detailed system status information, including: Current inverter status, Next operating status, Fault code, Alarm code, BUS1 voltage, BUS2 voltage, Positive BUS voltage, Negative BUS voltage, Temperature T1 (I/O board, highest value), Temperature T2 (mainboard, highest value), Exit reasons (1 and 2), Run trace information.</p>
----	-------	---

Index	Description	Notice
1	Fault Status	 <p>This page displays the fault status of the inverter. If a fault occurs, the corresponding fault code will be shown. If there is no fault, the page will remain blank (no fault displayed).</p>
2	Alarm Status	 <p>This page shows the inverter's alarm status. When an alarm is triggered, the corresponding alarm code will be displayed. If there is no alarm, the page will show "NO Alarm".</p>

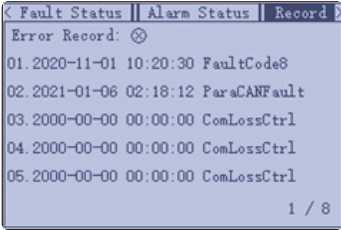
<p>3</p>	<p>Record</p>	 <p>This page lists the historical fault and alarm records, including the date and time of each event. Pages 1-4 display the fault history. Pages 5-8 display the alarm history.</p>
----------	---------------	---

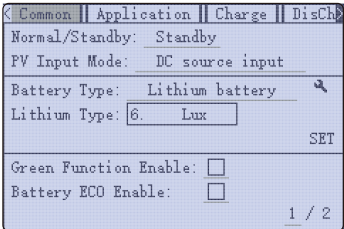
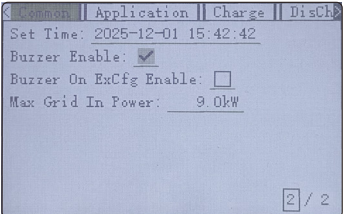
Index	Description	Setting
<p>1</p>	<p>Common (1)</p>	 <p>This page displays the following settings: Inverter operating status (Normal / Standby), PV input mode (DC source / PV1 & PV2 independent / PV1 & PV2 parallel), Battery type (lithium / lead-acid / no battery), Lithium battery brand selection (up to 24 brands), Green function enable, Battery ECO mode enable, ISO (insulation detection) enable</p> <p>Note: For a complete list of compatible lithium battery brands, please visit the LuxpowerTek official website or contact your device provider.</p>
<p>2</p>	<p>Common (2)</p>	 <p>The second page displays the following settings: System time (year / month / day), Buzzer enable/disable. Note: The maximum grid input power is 9 kW.</p>

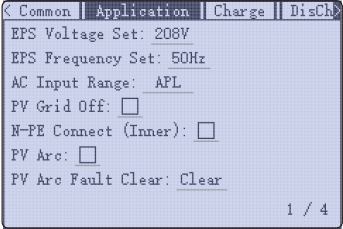
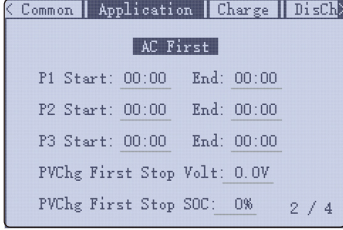
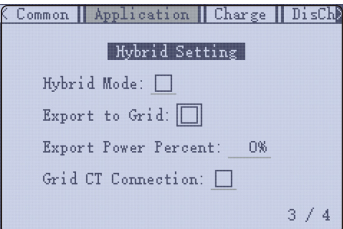
<p>3</p>	<p>Application (1)</p>	 <p>This page displays the following settings: EPS output voltage options (240 / 230 / 220 / 208 / 200 Vac), EPS output frequency (50 Hz or 60 Hz), AC input range (UPS mode: 170–280 V, APL mode: 90–280 V), PV Off-Grid function enable, N-PE connection enable, AFCI enable and fault clear.</p>
<p>4</p>	<p>Application (2)</p>	 <p>The second page displays the following setting: AC-priority charging schedule (up to three time periods can be configured). PVChg First Stop Volt (Max. voltage: 59.5 V(Default), and users may reduce it if needed.) PVChg First Stop SOC (Max. SOC: 101%(Default), and users may reduce this value as well.</p>
<p>5</p>	<p>Application (3)</p>	 <p>The third page displays mixed-mode and CT-related settings: PV & AC load jointly enable, Export to grid enable, Export power percentage setting, Grid CT connection enable, CT ratio selection (default 1000:1; also supports 2000:1 and 3000:1)</p>

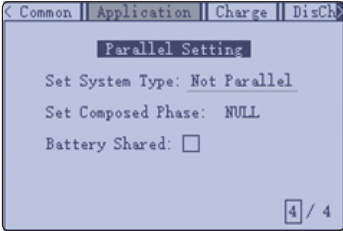
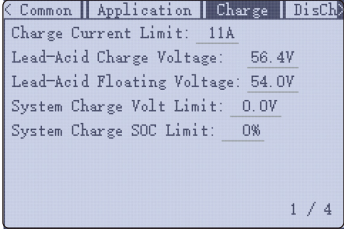
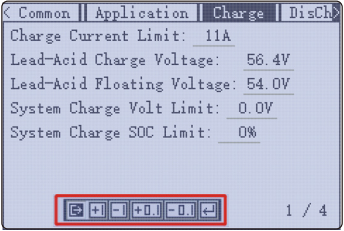
<p>6</p>	<p>Application (Parallel Settings)</p>	 <p>The fourth page contains the following information:</p> <ul style="list-style-type: none"> - Parallel system type (Not Parallel / Single-phase parallel / Three-phase parallel) - Composed phase setting (R, S, T) - Battery Shared option: Enable this function only when the actual system wiring supports shared battery usage among multiple inverters.
<p>7</p>	<p>Charge (1)</p>	 <p>The first page contains the following information:</p> <ul style="list-style-type: none"> - Battery charging current limit; - Constant-voltage (CV) charging voltage setting for lead-acid batteries; - Floating charging voltage setting for lead-acid batteries. <p>Max. default charge Volt: 59.5 V, Max. default charge SOC: 101%.</p>
<p>8</p>	<p>Charge (Numerical setting operation)</p>	 <p>This page is used for numerical setting adjustments. Press DOWN to enter the value-adjustment mode. Use +1, -1, +0.1, -0.1 to change values, and press ENTER to confirm. Press UP to exit.</p> <p>Example: If the cursor is on +1, pressing ENTER sets 55 → 56. If on -1, 55 → 54. If on -0.1, 55.0 → 54.9. If on +0.1, 55.0 → 55.1.</p>

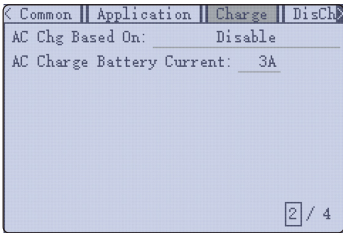
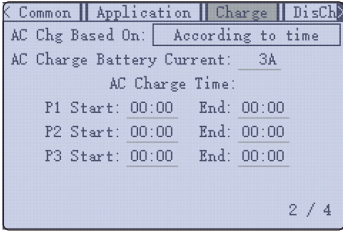
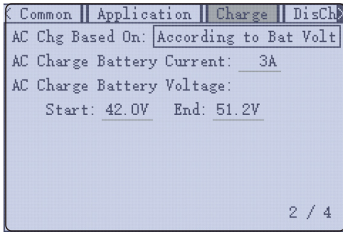
<p>9</p>	<p>Charge (2)</p>	 <p>The second page contains the following information: AC charging mode enable settings, AC charging current setting.</p>
<p>10</p>	<p>Charge (according to the time)</p>	 <p>This page shows the AC charging settings based on time. The inverter provides three time periods (P1, P2, P3). When the system enters any enabled time period, AC charging will start automatically.</p>
<p>11</p>	<p>Charge (according to the battery voltage)</p>	 <p>This page shows the AC charging settings based on battery voltage. You can set the start voltage and cut-off voltage. When the battery voltage falls below the start value, AC charging begins; when it reaches the cut-off value, charging stops.</p>

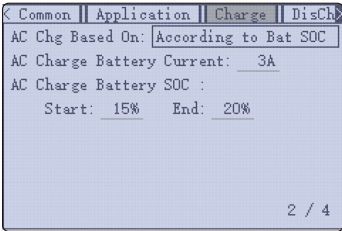
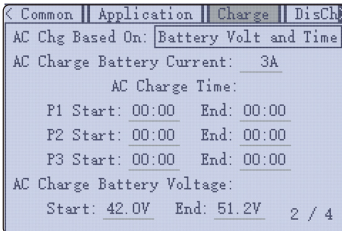
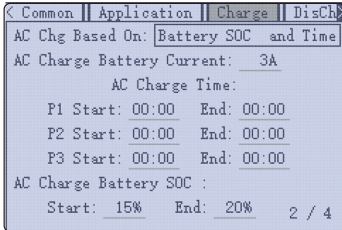
<p>12</p>	<p>Charge (according to the battery SOC)</p>	 <p>This page shows the AC charging settings based on battery SOC. You can set the start SOC and stop SOC. When the battery SOC drops below the start SOC, AC charging starts; when it reaches the stop SOC, charging ends.</p>
<p>13</p>	<p>Charge (according to the battery voltage and time)</p>	 <p>This page combines time-based charging and voltage-based charging. AC charging will start when the system meets both conditions:</p> <ul style="list-style-type: none"> - it is within any of the three time periods, and - the battery voltage is between the start and cut-off voltage.
<p>14</p>	<p>Charge (according to time and SOC)</p>	 <p>This page combines time-based charging and SOC-based charging. AC charging will start when the system meets both conditions:</p> <ul style="list-style-type: none"> - it is within any of the three time periods, and - the battery SOC is between the start and stop SOC.

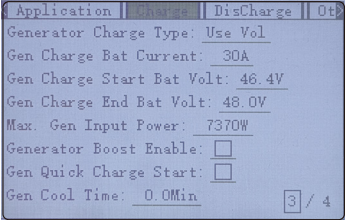
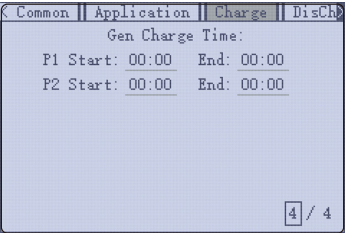
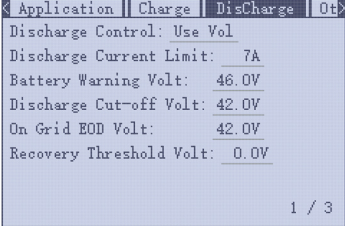
<p>15</p> <p>Charge (Generator Settings)</p>		 <p>This page contains information about generator-charging settings. You can set the generator charging current, start/stop voltage, and start/stop SOC. The maximum generator input power and the Generator Boost function can also be configured. Max. generator input power: 7370W</p>
<p>16</p> <p>Charge (Gen Charge Time Settings)</p>		 <p>This page allows the user to configure two charging time periods for the generator.</p>
<p>17</p> <p>Discharge (Voltage / SOC Settings)</p>		 <p>This page contains information about discharge settings based on voltage or SOC. You can set the discharge current limit, battery alarm voltage, off-grid cutoff voltage, and on-grid cutoff voltage. The on-grid cutoff voltage is higher than the off-grid cutoff voltage, and both ranges complement each other. Recovery Threshold Volt: 3V(default).</p>

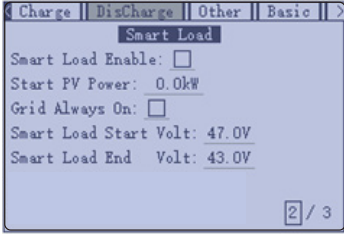
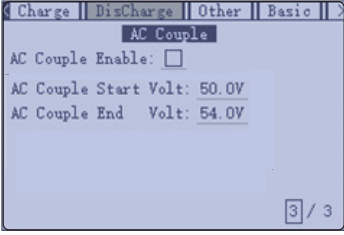
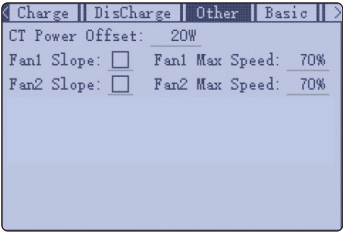
<p>18</p> <p>Discharge (Smart Load)</p>		 <p>This page contains settings for the Smart Load function. When the actual PV input power exceeds the set value, Smart Load is enabled. When connected to the grid, the Smart Load is normally open. You can set the Smart Load start/end voltage points .</p>
<p>19</p> <p>Discharge (AC Couple)</p>		 <p>This page contains AC Coupling settings. You can enable AC Couple, set the start voltage and cutoff voltage for AC Coupling operation.</p>
<p>20</p> <p>Other (Fan & CT Settings)</p>		 <p>This page contains CT compensation settings and fan control settings. You can configure CT power offset, set the maximum fan speed, and adjust slope curves for two independent fan channels.</p>

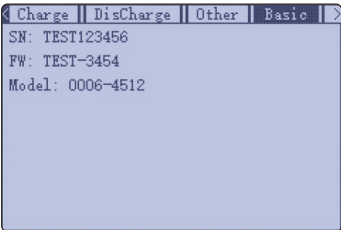
<p>21</p>	<p>Basic (Device Information)</p>	 <p>This page displays basic inverter information. SN indicates the serial number. FW shows the firmware version. Model displays the internal model code of the inverter.</p>
-----------	---------------------------------------	--

5. About LCD Settings check the operation

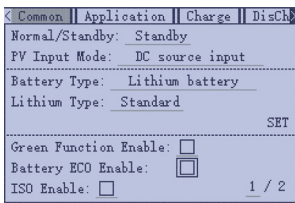
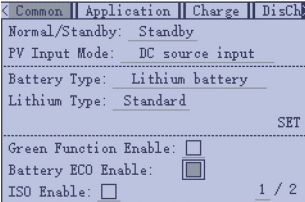
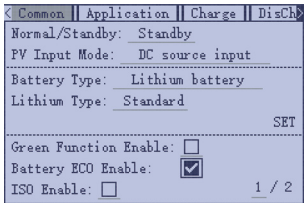
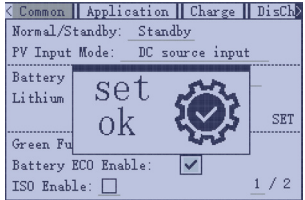
	<p>→ Enter →</p>	
<p>→ UP or Down →</p>		
<p>→ Enter →</p>		

6. SNA Series Inverter Monitoring System

Users can monitor the system via App and Web, App name is “LuxCloud”, monitoring website: server.luxpowertek.com

We will use the LuxCloud App as an example. Please follow the steps below to download the app, register your account, and connect your device.

1. Download and install the “LuxCloud” App. QR codes for Android and iOS downloads are shown below.



Android



IOS

Registration Note:

When registering a Monitor account, if you are an end user, please request the Installer Code from your device provider (installer or distributor). You may also ask your device provider to help you complete the account registration directly.

2. Check Device Status. After the system is properly connected, power on the device.

Observe the LCD screen: wait for the icon  to appear, indicating that the data logger is connected but not yet configured for the network. If no icon appears on the LCD, please contact your device provider.

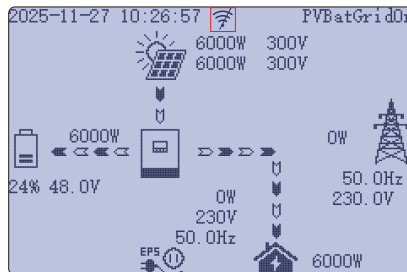

3. Connect the dongle. Recommended: Connect via Bluetooth

a. Log in and Create a Plant

Log into your App account. Tap “Create Plant”, allow location permission when prompted, fill in the basic plant information, and save.

Create a Plant

- 1). Tap Create Plant to create a new site.
- 2). Allow the App to access your location information (optional).
- 3). Fill in your personal information.
- 4). Complete the plant creation and proceed to Dongle matching.

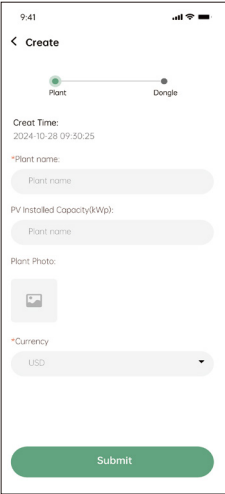
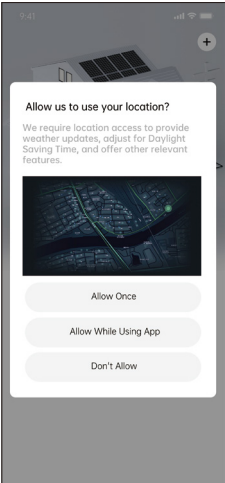

b. In the pop-up window, tap **Next**. Turn on your phone's Bluetooth and tap **Add by Bluetooth**. At this time, the icon on the screen will still remain the same icon  as before.

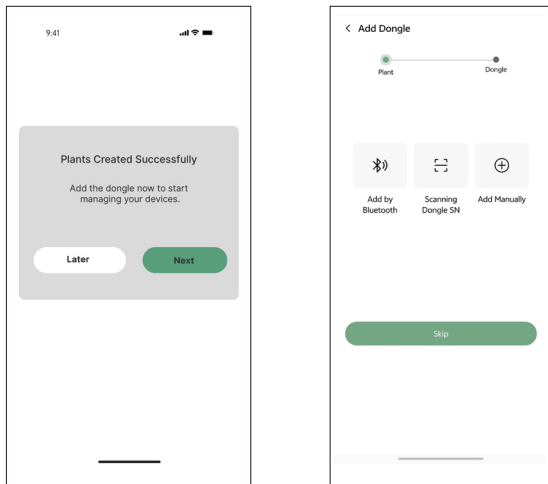

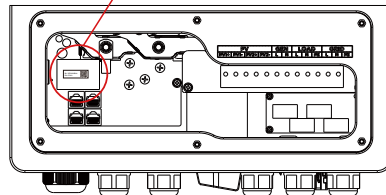
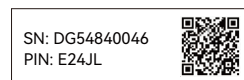
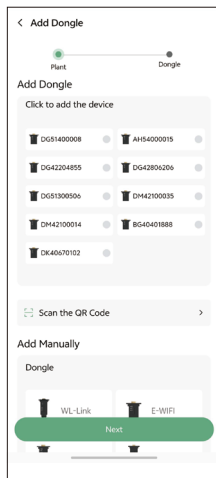

c. Select the serial number that matches the one on the device sticker and tap **Next**. (The dongle serial number is located inside the device, as shown in the illustration below.)



d. On the next screen, select your home Wi-Fi network, enter the Wi-Fi password, and tap **Save**.



e. The dongle will reboot automatically. After completing the configuration, tap **Done**. Then check the icon on the LCD screen: after about 20 seconds, an icon  will appear; after another 1 minute, it will switch to the normal network-connection icon , indicating that the device has successfully connected to the network.

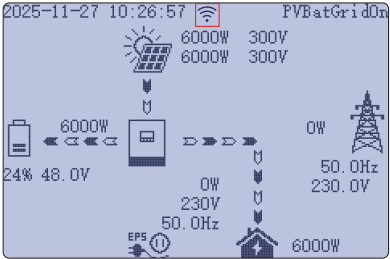
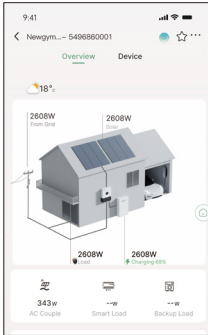
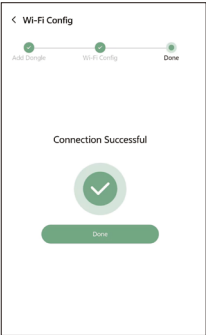

For more network configuration instructions, visit the LuxpowerTek official website to download the “LuxCloud User Manual.” If you encounter any issues, please contact your device provider or reach out to LuxpowerTek for assistance.

7. Specifications

Table 1 MPPT Mode Specifications					
INVERTER MODEL	SNA PRO-EU-3K	SNA PRO-EU-4K	SNA PRO-EU-5K	SNA PRO-EU-6K	SNA PRO-EU-6.5K
Max. PV Array Power(W)	7500	10000	12500	15000	15000
Max. PV Input Power(W)	6000	8000	10000	12000	12000
Rated PV Input Voltage(V)	320				
Number of Independent MPPT Inputs	2				
Number of string per MPPT	1				
PV Input Voltage Range(V)	80~500				
MPPT Voltage Range(V)	80~400				
Start-up Voltage(V)	80				
Max. PV Input Current per MPPT (A)	20/20				
Max. PV Short-circuit Current per MPPT(A)	25/25				
Max. PV Charging Current for Battery (A)	70	90	110	135	135
Table 2 Battery Mode Specifications					
INVERTER MODEL	SNA PRO-EU-3K	SNA PRO-EU-4K	SNA PRO-EU-5K	SNA PRO-EU-6K	SNA PRO-EU-6.5K
Output Voltage Waveform	Pure Sine Wave				
Output Voltage Regulation	208Vac / 220Vac / 230Vac / 240Vac±5%				
Output Frequency	50Hz / 60Hz				
PV+Battery Output Power (W)	3000	4000	5000	6000	6500
Rated Output Current(A)	13	17.5	22	26.5	28.2
Max. Charging / Discharging Current(A)	70/70	90/90	110/110	135/140	135/140
Max. Charging / Discharging Power(W)	3000	4000	5000	6000	6500
Overload Protection	10S@110%~150%load、5S@1500%~200%load				
Surge Capacity	2* rated power within 5 seconds				
Recommend Capacity of Battery per Inverter	>150AH	>200AH	>200AH	>300AH	>300AH
Battery Voltage Range	46.4V~60V(Li)		38.4V~60V(Lead_Acid)		
High DC Cut-off Voltage	59VDC(Li)		60VDC(Lead_Acid)		
High DC Recovery Voltage	57.4VDC(Li)		58VDC(Lead_Acid)		

Low DC Warning Voltage(Lead Acid)	load < 20%	44.0Vdc(Settable)
	20% ≤ load < 50%	Warning Voltage@load < 20% -1.2V
	load ≥ 50%	Warning Voltage@load < 20% -3.6V
Low DC Warning Return Voltage(Lead Acid)		Low DC Warning Voltage@Different load+2V
Low DC Cut-off Voltage(Lead Acid)	load < 20%	42.0Vdc(Settable)
	20% ≤ load < 50%	Cut-off Voltage@load < 20% -1.2V
	load ≥ 50%	Cut-off Voltage@load < 20% -3.6V
Low DC Cut-off Return Voltage(Lead Acid)	Cut-off Voltage@load<20%≥45V	Low DC Cut-off Voltage@load<20%+3V
	Cut-off Voltage@load<20%<45V	48V
Low DC Warning SOC		20% SOC(Settable)
Low DC Warning Return SOC		Low DC Warning SOC +10%
Low DC Cut-off SOC		15% SOC (Grid on) (settable)
		15% SOC (Grid off) (settable)
Low DC Cut-off Return SOC		Low DC Cut-off SOC +10%
Charge Cut-off Voltage		58.4Vdc
No Load Power Consumption		<50W
Lead_Acid Battery Charging Algorithm		3-Step
Absorption Charging Voltage		Flooded Battery 58.4Vdc (Recommend)
		AGM / Gel Battery 56.4Vdc (Recommend)
Floating Charging Voltage		54Vdc
<p>Charging Curve</p>		

Table 3 Line Mode Specifications

INVERTER MODEL	SNA PRO- EU-3K	SNA PRO- EU-4K	SNA PRO- EU-5K	SNA PRO- EU-6K	SNA PRO- EU-6.5K
Input Voltage Waveform	Sinusoidal(utility or generator)				
Nominal Input Voltage(V)	230Vac				
Low Loss Voltage	170Vac±7V(UPS); 90Vac±7V(Appliances)				
Low Loss Return Voltage	180Vac±7V(UPS); 100Vac±7V(Appliances)				
High Loss Voltage	280Vac±7V				
High Loss Return Voltage	270Vac±7V				
Max. AC Input Voltage	280Vac				
Nominal Input Frequency	50Hz/60Hz(Auto detection)				
Max. AC Input Current(A)	26	35	44	53	56.4
Max. AC Input Power(W)	6000	8000	10000	12000	13000
Rated AC Output Current(A)	13	17.5	22	26.5	28.2
Rated AC Output Power(W)	3000	4000	5000	6000	6500
Output Short Circuit Protection	Software Protect				
Transfer Time	<10ms				

Table 4 Generator Mode Specifications

INVERTER MODEL	SNA PRO- EU-3K	SNA PRO- EU-4K	SNA PRO- EU-5K	SNA PRO- EU-6K	SNA PRO- EU-6.5K
Rated GEN Voltage(V)	230				
Rated GEN Frequency(Hz)	50/60				
Rated GEN Input Current(A)	13	32	32	32	32
Rated GEN Input Power(W)	3000	7370	7370	7370	7370

Table 5 Protection/General Specifications

INVERTER MODEL	SNA PRO- EU-3K	SNA PRO- EU-4K	SNA PRO- EU-5K	SNA PRO- EU-6K	SNA PRO- EU-6.5K
Over Current / Voltage Protection	YES				
Grid Monitoring	YES				
AC Surge Protection Type III	YES				
Safety Certification	CE				
Ingress Protection Rating	IP 65				
Display&Communication Interface	LCD+LED, RS485 / WIFI / CAN				
Warranty	5 Years				
Cooling Method	Smart Cooling				
Topology	Transformerless				
Noise Emission(typical)	<45dB				
Operating Temperature Range	-20°C to 60°C (>45°C load derating)				
Storage temperature	-40°C ~ 65°C				
Humidity	5% to 95% Relative Humidity(Non-condensing)				
Altitude	4000m,>2000m Power derating				
Dimension(D*W*H)mm	382*432*186.6mm				
Net Weight	16.95kg				

8. Maintenance

This chapter describes the safety precautions and procedures for inverter maintenance, replacement, and routine inspection.

All operations must be carried out by qualified personnel, and only after the power has been completely disconnected.

8.1 Power OFF the Inverter

WARNING

Before performing any maintenance, cleaning, or removal work, the inverter must be powered off and all power sources disconnected to prevent electric shock or equipment damage.

Operating Procedures

Step 1: Turn off the PV input breaker.

Step 2: Turn off the battery breaker.

Step 3: Turn off the AC output breaker (load side) and AC input breaker (utility or generator side).

Step 4: Switch off the inverter main power switch.

Step 5: Wait until the inverter display is completely off.

Step 6: Confirm that no voltage is present before proceeding with any further operation.

8.2 Removing the Inverter

WARNING

Before removing the inverter, make sure all power sources are completely disconnected to avoid electric shock or short circuit.

This procedure must be performed by a qualified electrician

Operating Procedures

Step 1: Power off the system

- Follow the steps described in 7.1 Power OFF the Inverter to ensure complete power disconnection.
- Verify that all indicator lights are off.

Step 2: Disconnect the cables

- Use a screwdriver to remove the PV connection cables.
- Carefully disconnect the battery and communication cables.
- Loosen and remove the AC input and output cables.
- Label each cable for easy reinstallation.

Step 3: Remove the inverter

- Hold the bottom of the inverter firmly with both hands, and use a Phillips screwdriver to remove the two mounting screws on the top and two on the bottom.
- Carefully lift and remove the inverter from the mounting bracket.

Step 4: Packaging and storage

- Repack the inverter using its original packaging materials if available.
- Store the device in a dry, ventilated, and dust-free environment.
- Do not place heavy objects on top of the inverter to prevent deformation or damage.

8.3 Disposing of the Inverter

When the inverter or any of its components reaches the end of its service life or cannot be repaired, it must be disposed of in accordance with local environmental regulations.

- Do not dispose of the inverter as household waste.
- The unit contains electronic and metal components that should be sent to a qualified recycling facility.
- Batteries, capacitors, and similar components must be handled as hazardous waste in accordance with local standards.
- If you have any questions, contact the manufacturer or an authorized local service center for recycling guidance.

8.4 Trouble Shooting & Error List

The failures mainly divided into 5 categories, for each category, the behavior is different:

Code	Description	Trouble shooting
E000	Internal communication fault1	Restart inverter, if the error still exist, contact us (DSP&M3)
E002	Bat On Mos Fail	Restart inverter, if the error still exist, contact us
E003	CT Fail	Restart inverter, if the error still exist, contact us
E008	CAN communication error in Parallel System	Check CAN cable connection is connected to the right COM por
E009	No master in parallel system	Check parallel setting for master/Slave part, there should be one master in the system
E012	UPS output short circuit	Check if the load is short circuit, try to turn off the load and restart inverter
E013	UPS reserve current	Restart inverter, if the error still exist, contact us
E015	Phase Error in three phase parallel system	Check if the AC connection is right for three phase system, there should one at least one inverter in each phase
E016	Relay fault	Restart inverter, if the error still exist, contact us
E017	Internal communication fault2	Restart inverter, if the error still exist, contact us (DSP&M8)
E018	Internal communication fault3	Restart inverter, if the error still exist, contact us (DSP&M3)
E019	Bus voltage high	Check if PV input voltage is higher than 480V
E020	EPS connection fault	Check if EPS and AC connection is in wrong terminal
E021	PV voltage high	Check PV input connection and if PV input voltage is higher than 480V
E022	Over current internal	Restart inverter, if the error still exist, contact us
E024	PV short	Check PV connection
E025	Temperature over range	The internal temperature of inverter is too high, turn off the inverter for 10minutes, restart the inverter, if the error still exist, contact us
E026	Internal Fault	Restart inverter, if the error still exist, contact us (Bus sample)
E028	Sync signal lost in parallel system	Check CAN cable connection is connected to the right COM port
E029	Sync trigger signal lost in parallel system	
E031	Internal communication fault4	Restart inverter, if the error still exist, contact us (DSP&M8)

Code	Description	Trouble shooting
W000	Communication failure with battery	Check if you have choose the right battery brand and communication cable is right, if the warning still exist, contact us
W003	Communication failure with meter	Check communication cable, if the warning still exist, contact us
W004	Battery failure	Inverter get battery fault info from battery BMS, restart battery, if the warning still exist, contact us or battery manufacture
W008	Platform mismatch	Please contact Luxpower for firmware update
W009	Fan Stuck	Check if the fan is OK
W012	Bat On Mos	Restart inverter, if the error still exist, contact us
W013	Over temperature	The temperature is a little bit high inside inverter
W015	Bat Reverse	Check the battery connection with inverter is right, if the warning still exist, contact us
W018	AC Frequency out of range	Check AC frequency is in range
W019	AC inconsistent in parallel system2	Reconnect the AC input or Restart inverter, if the error still exist, contact us
W025	Battery voltage high	Check if battery voltage is in normal range
W026	Battery voltage low	Check if battery voltage is in normal range, need to charge the battery if battery voltage is low
W027	Battery open	Check if there is output from the battery and battery connection with inverter is OK
W028	EPS Over load	Check if EPS load is too high
W029	EPS voltage high	Restart inverter, if the error still exist, contact us
W031	EPS DCV high	Restart inverter, if the error still exist, contact us

■ YOUR RELIABLE ENERGY SOLUTION PARTNER



Lux Power Technology Co., Ltd
Headquarter: +86 755 8520 9056
www.luxpowertek.com
Contact us: info@luxpowertek.com



092.20122AB